

Indice • Index

Locomotive a vapore.	120
Locomotive diesel	132
Locomotive elettriche	142
Carrozze	164
Carri	184
Prodotti disponibili	200

<i>Steam locomotives.</i>	<i>120</i>
<i>Diesel locomotives.</i>	<i>132</i>
<i>Electric locomotives.</i>	<i>142</i>
<i>Coaches</i>	<i>164</i>
<i>Wagons</i>	<i>184</i>
<i>Available Products</i>	<i>200</i>

Rivarossi®

Rivarossi è da ormai quasi 80 anni il riferimento del fermodellismo italiano. Grandi dettagli, curati finemente, e una lunga storia lo hanno reso un marchio sinonimo di qualità.

Siamo lieti di presentare in questo catalogo tutte le nostre novità, che, come ogni anno, abbiamo selezionato con cura cercando di andare incontro alle esigenze dei modellisti. Anche il catalogo 2024 quindi è ricco di proposte: oltre alla conferma di progetti annunciati in precedenza, come la locomotiva a vapore FS Gr. 685 e la “draisina” KLV 53, tra i nuovi annunci vi sono anche, a grande richiesta, le locomotive elettriche E656/E655 “Caimano” delle FS interamente riprogettate secondo gli standard qualitativi odierni, che vanno a completare la grande famiglia di locomotive articolate FS.

Ma non vi è solo materiale motore: anche per carrozze e carri stiamo procedendo con l’ampliamento dell’offerta, con nuove versioni di carrozze CIWL ed UIC-X non riprodotte in precedenza ed una vasta scelta di carri merci di diverse tipologie ed amministrazioni, per tutti i gusti.

Abbiamo lavorato duramente per mantenere standard di altissima eccellenza, con un occhio di riguardo ai nostri appassionati che per noi sono fonte instancabile d’ispirazione. Rivarossi sei tu, che dal modellismo ferroviario pretendi sempre il meglio!



www.rivarossi.com



FS Gr. 685



Locomotiva FS.685

Le locomotive del gruppo 685 sono la versione a vapore surriscaldato e a semplice espansione della precedente serie di locomotive del gruppo 680 delle Ferrovie dello Stato di cui ricalcano l'impostazione meccanica generale e le dimensioni. Furono costruite su progetto dell'Ufficio Studi di Firenze delle FS in 241 esemplari con distribuzione Walschaerts e 30 con distribuzione a valvole sistema Caprotti (queste ultime inizialmente classificate nel gruppo 686), entrate in servizio a partire dal 1912. Successivamente, tra il 1921 e il 1930 iniziò la trasformazione in 685 di un consistente quantitativo di locomotive 680 che diede origine alle serie 685.300 (con distribuzione Walschaerts) e 685.500 (con distribuzione Caprotti). Tra 1931 e 1934 un ulteriore gruppo di 50 unità 680 venne trasformato mediante l'applicazione della distribuzione Caprotti, di un surriscaldatore e di un preriscaldatore Knorr dando luogo al sottogruppo S.685.

La locomotiva 685 rappresenta senz'altro il compendio della massima espressione tecnologica italiana legata alla trazione ferroviaria a vapore e non a caso questa macchina, che in mani esperte era capace di regalare ottime prestazioni, venne affettuosamente ed informalmente ribattezzata "La Regina". Le unità del gruppo prestarono un importante servizio attivo fino agli anni '60.

**FS, locomotiva a vapore Gr. 685, 2a serie, con caldaia corta, locomotiva storica, ep. V-VI**

FS, Dampflokomotive Gr. 685, 2. Serie, mit kurzem Kessel, historische Lokomotive, Ep. V-VI

FS, locomotive à vapeur Gr. 685, 2^{ème} série, avec chaudière courte, locomotive historique, ép. V-VI

FS, locomotora de vapor Gr 685, segunda serie, con caldera corta, locomotora histórica, ép. V-VI

FS, steam locomotive Gr. 685 089, 2nd series, with short boiler, historic locomotive, period V-VI

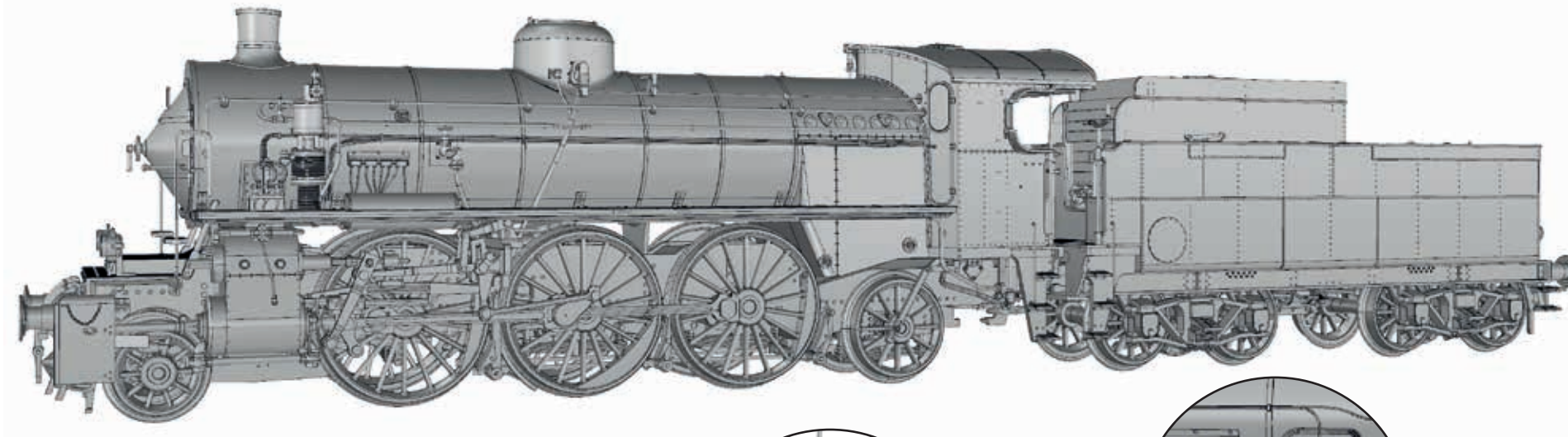
**Il nuovissimo modello Rivarossi nei punti chiave:**

- Riproduzione in perfetta scala H0 1:87 delle unità di prima e seconda serie con caldaia corta
- Tender FS a carrelli da 22 m3 interamente di nuova costruzione
- Interfaccia 21MTC (NEM 660) per decoder digitale nel tender
- Predisposizione per impianto sonoro con due altoparlanti "sugar cube" nel tender
- Telaio, ruote e caldaia in metallo pressofuso
- Telaio finemente riprodotto e dettagliato, con struttura "aperta"
- Riproduzione funzionante delle bielle motrici interne al telaio
- Ruote motrici con bordino ribassato a norme NEM 311.1 e razze in scala
- Cinematismo di allontanamento tra macchina e tender, con condotta elettrica e regolabile in lunghezza
- Portagancio NEM 362 con timone di allontanamento sulla testata posteriore del tender
- Possibilità di installazione del gancio modellistico a norma NEM 363 sulla testata anteriore della macchina
- Riproduzione completa della cabina di guida, con illuminazione interna
- Illuminazione del forno
- Fanali anteriori a petrolio o elettrici in base alla versione, entrambi illuminati
- Fanali posteriori sul tender presenti su alcune versioni, riproduzione delle lanterne di coda opzionali
- Raggio minimo di curvatura: 420 mm

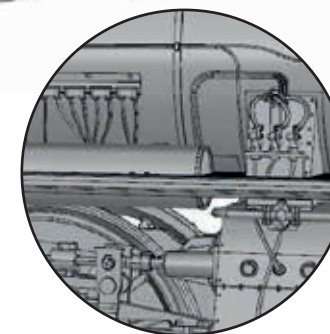
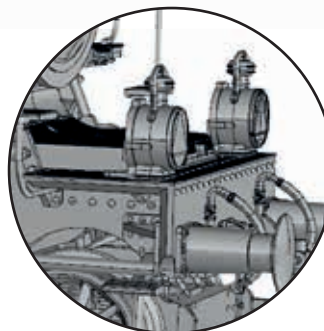

- Con forno illuminato (DC) o scoppiettante (in digitale)
- Mit glühender (DC) bzw. flackerner (im Digitalbetrieb) Feuerbüchse
- Avec boîte à feu lumineuse (DC) ou scintillant (en mode digital)
- Con fogón iluminado (DC) o parpadeando (en modo digital)
- With glowing (DC) or flickering (in digital mode) firebox



**HR2914/HR2914S****FS****NEW****FS, locomotiva a vapore Gr. 685, 2a serie, con caldaia corta e fanali a petrolio, ep. III**

FS, Dampflokomotive Gr. 685, 2. Serie, mit kurzem Kessel und Öllampen, Ep. III

FS, locomotive à vapeur Gr. 685, 2^{ème} série, avec chaudière courte et lampes à huile, ép. III

FS, locomotora de vapor Gr 685, segunda serie, con caldera corta y luces a petroleo, ép. III

FS, steam locomotive Gr. 685, 2nd series, with short boiler and oil lamps, period III



- Con forno illuminato (DC) o scoppiettante (in digitale)
- Mit glühender (DC) bzw. flackerner (im Digitalbetrieb) Feuerbüchse
- Avec boîte à feu lumineuse (DC) ou scintillant (en mode digital)
- Con fogón iluminado (DC) o parpadeando (en modo digital)
- With glowing (DC) or flickering (in digital mode) firebox

**HR2915/HR2915S****FS****NEW****FS, locomotiva a vapore Gr. 685, 1a serie, con caldaia corta e fanali elettrici, ep. III**

FS, Dampflokomotive Gr. 685, 1. Serie, mit kurzem Kessel und elektrischen Lampen, Ep. III

FS, locomotive à vapeur Gr. 685, 1^{ère} série, avec chaudière courte et lampes électriques, ép. III

FS, locomotora de vapor Gr 685, primera serie, con caldera corta y luces eléctricas, ép. III

FS, steam locomotive Gr. 685, 1st series, with short boiler and electric lamps, period III

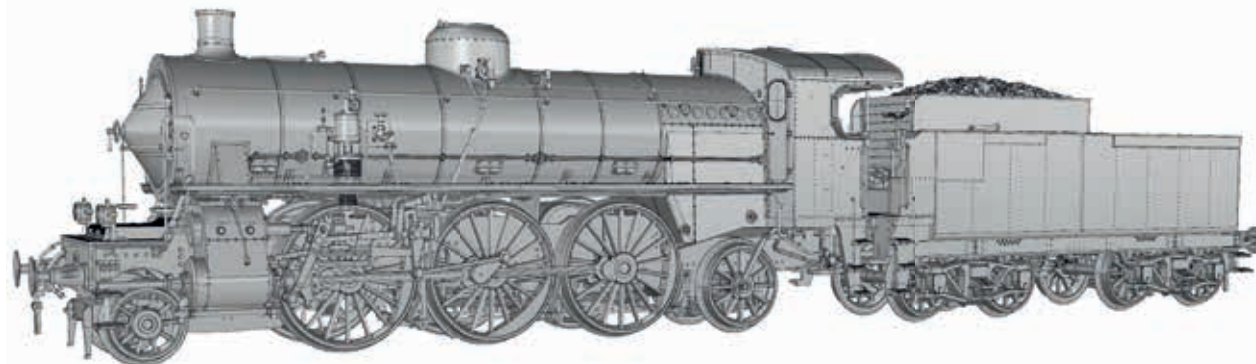

- Con forno illuminato (DC) o scoppiettante (in digitale)
- Mit glühender (DC) bzw. flackerner (im Digitalbetrieb) Feuerbüchse
- Avec boîte à feu lumineuse (DC) ou scintillant (en mode digital)
- Con fogón iluminado (DC) o parpadeando (en modo digital)
- With glowing (DC) or flickering (in digital mode) firebox





HR2956/HR2956S



FS

NEW

FS, locomotiva a vapore Gr. 940, con fanali a petrolio, ep. III

FS, vierachsige Tenderlokomotive der Reihe 940, mit Öllampen, Ep. III

FS, locomotive à tender à vapeur Gr. 940, avec lampes à huile, ép. III

FS, locomotora de vapor Gr. 940, con lámparas de aceite, ép. III

FS, steam tender locomotive Gr. 940, with oil lamps, ep. III

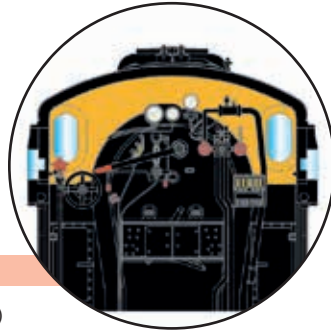

Locomotiva Gr. 940

- Nuovo impianto elettrico con interfaccia per decoder (NEM 662)
- Nuovo impianto sonoro, con altoparlante "sugar cube" 11 x 15 mm
- Versioni DCC Sound di fabbrica, mai prodotte in precedenza
- Nuova riproduzione della traversa completa del carrello anteriore
- Nuovi dettagli su caldaia, cabina e sottocassa differenziati in base all'epoca
- Numerazioni inedite

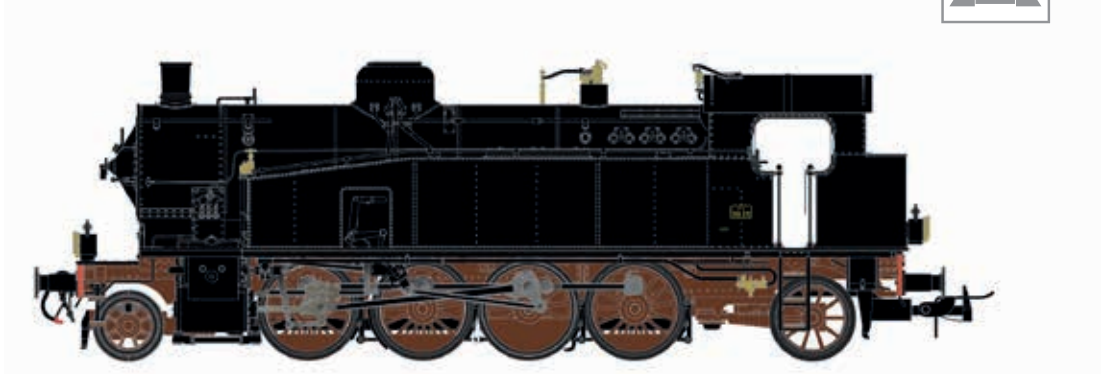

HR2957/HR2957S



FS

NEW

FS, locomotiva a vapore Gr. 940, con fanali elettrici, ep. III-IV

FS, vierachsige Tenderlokomotive der Reihe 940, mit elektrischen Lampen, Ep. III-IV

FS, locomotive à tender à vapeur Gr. 940, avec lampes électriques, ép. III-IV

FS, locomotora de vapor Gr. 940, con lámparas de eléctricas, ép. III-IV

FS, steam tender locomotive Gr. 940, with electric lamps, ep. III-IV

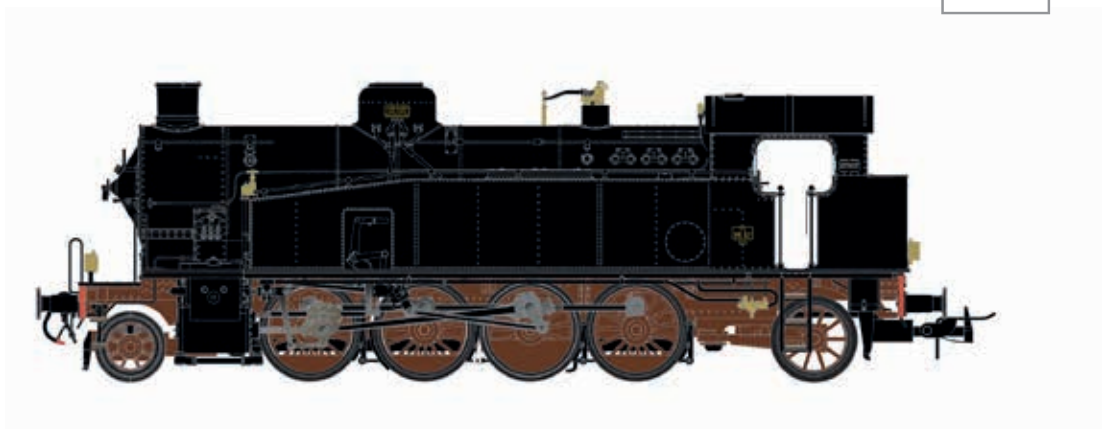
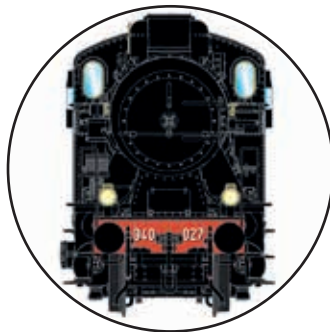

**DB, locomotiva a vapore classe 56.20, caldaia con 3 duomi, livrea nera/rossa, ep. III**

DB, Dampflokomotive Baureihe 56.20, dreidomiger Kessel, in schwarz/roter Lackierung, Ep. III

DB, locomotive à vapeur classe 56.20, chaudière avec 3 coupoles, livrée noire/rouge, ép. III

DB, locomotora de vapor clase 56.20, caldera con 3 domos, decoración negra/roja, ép. III

DB, steam locomotive class 56.20, 3-dome boiler, black/red livery, period III

**Die Dampflokomotiven der Bauart G 8.3 (BR 56²⁰)**

Im Zusammenhang mit der Entwicklung der fünffach gekuppelten Güterzuglokomotive der Gattung G 12 kam der Wunsch nach einer vierfach gekuppelten Maschine für den mittelschweren Dienst auf. So leitete man aus der 1'Eh3 Lok der Gattung G 12 die 1'Dh3 Lokomotiven der Gattung G 8.3 ab.

Allerdings blieben diese Lokomotiven hinsichtlich Leistung und Verbrauch deutlich hinter den Erwartungen zurück, so das nach 85 gebauten Exemplaren der einfacheren Zweizylinder-Bauart G 8.2 (1'Dh2) der Vorzug gegeben wurde.

Insgesamt verließen 846 Lokomotiven diese Typs bis 1928 die Werkhallen mehrerer deutscher Lokomotivwerke. Haupteinsatzgebiete waren Mittel- und Westdeutschland in den Direktionen Köln, Essen, Hannover, Münster, Altona, Magdeburg und Halle(Saale).

Dort bewältigten sie zum größten Teil den hochwertigen Güterverkehr, kamen aber auch vor Reisezügen zum Einsatz.

Nach dem zweiten Weltkrieg verblieben mehr als 500 Maschinen der Baureihe 5620 in der Bundesrepublik Deutschland, sie wurden bis 1963 durch andere Lokomotivbauarten verdrängt und ausgemustert.

Bei der DR in der Deutschen demokratischen Republik konnten sie bis 1970 im Einsatz beobachtet werden, einige davon als Rangierlokomotiven mit speziellen Tritten an der rechten Lokfront.



© Willi Marotz

- Con forno illuminato (DC) o scoppiettante (in digitale)
- Mit glühender (DC) bzw. flackerner (im Digitalbetrieb) Feuerbüchse
- Avec boîte à feu lumineuse (DC) ou scintillant (en mode digital)
- Con fogón iluminado (DC) o parpadeando (en modo digital)
- With glowing (DC) or flickering (in digital mode) firebox



**HR2890/HR2890S****DR****DR, locomotiva a vapore classe 56.20, caldaia con 3 duomi, livrea nera/rossa, ep. III**

DR, Dampflokomotive Baureihe 56.20, dreidomiger Kessel, in schwarz/roter Lackierung, Ep. III
 DR, locomotive à vapeur classe 56.20, chaudière avec 3 coupoles, livrée noire/rouge, ép. III
 DR, locomotora de vapor clase 56.20, caldera con 3 domos, decoración negra/roja, ép. III
 DR, steam locomotive class 56.20, 3-dome boiler, black/red livery, period III

- Con forno illuminato (DC) o scoppiettante (in digitale)
- Mit glühender (DC) bzw. flackerner (im Digitalbetrieb) Feuerbüchse
- Avec boîte à feu lumineuse (DC) ou scintillant (en mode digital)
- Con fogón iluminado (DC) o parpadeando (en modo digital)
- With glowing (DC) or flickering (in digital mode) firebox



© Photo Mag. A. Luft

**HR2891/HR2891S/HR2891ACS****DRG****DRG, locomotiva a vapore classe 56.20, caldaia con 3 duomi, livrea nera/rossa, ep. II**

DRG, Dampflokomotive Baureihe 56.20, dreidomiger Kessel, in schwarz/roter Lackierung, Ep. II
 DRG, locomotive à vapeur classe 56.20, chaudière avec 3 coupoles, livrée noire/rouge, ép. II
 DRG, locomotora de vapor clase 56.20, caldera con 3 domos, decoración negra/roja, ép. II
 DRG, steam locomotive class 56.20, 3-dome boiler, black/red livery, period II

- Con forno illuminato (DC) o scoppiettante (in digitale)
- Mit glühender (DC) bzw. flackerner (im Digitalbetrieb) Feuerbüchse
- Avec boîte à feu lumineuse (DC) ou scintillant (en mode digital)
- Con fogón iluminado (DC) o parpadeando (en modo digital)
- With glowing (DC) or flickering (in digital mode) firebox



© Photo Carl Bellingrodt

125



HR2892/HR2892S



DB

DB, locomotiva a vapore 055 632-4, livrea nera/rossa, ep. IV

DB, Dampflokomotive mit Schlepptender 055 632-4, in schwarz-roter Farbgebung, Ep. IV

DB, locomotive à vapeur 055 632-4, livrée noire/rouge, ép. IV

DB, locomotora de vapor 055 632-4, decoración negro/rojo, ép. IV

DB, steam locomotive with tender 055 632-4, black/red livery, ep. IV



Fotomontage / Fotomontaje / Photomontage / Fotomontaggio

- Con forno scoppiettante
- Mit flackerner Feuerbüchse
- Avec boîte à feu scintillant
- Con fogón parpadeante
- With flickering firebox



**Feinste Detaillierung
entsprechend des Vorbilds**



HR2893/HR2893S



DR

DR, locomotiva a vapore 55 7254, livrea nera/rossa, ep. III

DR, Dampflokomotive mit Schlepptender 55 7254, in schwarz-roter Farbgebung, Ep. III

DR, locomotive à vapeur 55 7254, livrée noire/rouge, ép. III

DR, locomotora de vapor 55 7254, decoración negro/rojo, ép. III

DR, steam locomotive with tender 55 7254, black/red livery, ep. III



© Collection Dirk Endisch

- Con forno scoppiettante
- Mit flackerner Feuerbüchse
- Avec boîte à feu scintillant
- Con fogón parpadeante
- With flickering firebox



17

Stromlinienzug
mit Dampflokomotive für 170 km Stf.

17

Stromlinienzug
mit Dampflokomotive für 170 km Stf.

17 Stromlinienzug

Stromlinienzug

Die Übergabe der Lokomotive fand am 31. Mai 1935 statt. Zugelassen war sie für eine Geschwindigkeit von bis zu 175 km/h, die mit den 2.300 Millimeter großen Treibrädern auch erreicht wurden, allerdings unter starken Zuckbewegungen, die auf das Zwei-Zylinder-Triebwerk zurückzuführen waren und sich sogar auf den Zug übertrugen. Man wollte daher der Lok keine Fahrplangeschwindigkeiten von bis zu 160 km/h zumuten und setzte deshalb diesen Stromlinienzug im Planverkehr zwischen Berlin und Dresden ein, wo die Höchstgeschwindigkeit damals bei 135 km/h lag. Die nach vorn abgeschrägtem Wasserbehälter gewährten Lokführer und Heizer eine rundum gute Streckensicht. Der „Blechmantel“, so die amtliche Beschreibung, verkleidete das Triebwerk komplett. Hier ist der Zug bei der Ausstellung zur Hundertjahrfeier der deutschen Eisenbahnen in Nürnberg zu sehen.

**HR2953/HR2953S****DRG****NEW****DRG, locomotiva a vapore ad alta velocità 61 001, livrea definitiva con treno Henschel-Wegmann (4 carrozze), ep. II**

DRG, Stromliniendampflokomotive 61 001 in endgültiger Farbgebung mit vierteiligem Henschel-Wegmann-Zug, Ep. II

DRG, locomotive à vapeur à grande vitesse 61 001, livrée définitive avec train Henschel-Wegmann (4 voitures), ép. II

DRG, locomotora de vapor de alta velocidad 61 001, decoración final con Henschel-Wegmann-Zug, ép. II

DRG, high-speed steam locomotive 61 001, final livery with Henschel-Wegmann train (4 coaches), ep. II

**Henschel-Wegmann-Zug**

Der Henschel-Wegmann-Zug wurde zunächst auf der Ausstellung zum 100-jährigen Bestehen der Deutschen Eisenbahnen vom 14. Juli bis 13. Oktober 1935 in Nürnberg ausgestellt und ging dann zur weiteren Bearbeitung nach Kassel. Mit Inkrafttreten des Sommerfahrplans 1936 befuhr die Henschel-Wegmann-Zug die Strecke Berlin – Dresden mit zwei Zugpaaren pro Tag. Dabei benötigte er für ein Strecke eine Stunde und 40 Minuten und übertraf damit den bisherigen Rekord um 28 Minuten, ein Rekord, der bis heute Bestand hat. In den offiziellen Berechnungen maß die Reichsbahn ihre Geschwindigkeit nur zwischen Berlin und der Dresdner Neustadt und vernachlässigte damit die letzten Kilometer bis zum Dresdner Hauptbahnhof. So konnte die Durchschnittsgeschwindigkeit des Zuges mit 111,2 km/h angegeben werden. Die kurze Wendezeit in Dresden zwischen den Verbindungen D 54 und D 57 war offensichtlich recht knapp.

Wie sich herausstellte, musste die Lokomotive nicht nur um den Zug herumfahren, sondern auch ihre Vorräte auffüllen. Zum Glück musste sie nicht zusätzlich noch auf der Drehscheibe gedreht werden. Dieses Wendezeitproblem wurde von der Reichsbahn im Winterfahrplan 1936 behoben.

Das neue Rivarossi-Modell im Detail

- Vollständige Neukonstruktion
- Viele angesetzte Details, größtenteils aus Metall
- Feine Speichenradsätze aus Metallspritzguss
- Spitzenbeleuchtung mit der Fahrtrichtung wechselnd
- Bestellnummern, die mit „S“ enden, sind ab Werk mit Sound ausgestattet
- Kurzkupplungskinematiken an beiden Enden der Lokomotive
- Mindestradius: 356,5 mm

DRG 61 001

Die Henschel-Wegmann-Zuggarnitur sollte in Konkurrenz zu den Dieseltriebwagen, die an den jeweiligen Endbahnhöfen einen schnellen Richtungswechsel erlaubten, fahren. Es war daher beabsichtigt, möglichst auf zeitraubende Prozeduren, wie beispielsweise das bei Schleptender-Schnellzuglokomotiven in aller Regel notwendige Wenden auf einer Drehscheibe, zu verzichten. Hieraus leitete sich ab, dass die Lokomotive der Zuggarnitur in beide Fahrrichtungen mit der gleichen Höchstgeschwindigkeit fahren können sollte, weshalb man sie als Tenderlokomotive ausführte.

Um die vorgesehenen Fahrleistungen erzielen zu können, wurde die Lokomotive ebenso wie die Wagen besonders leicht ausgelegt; die Kohle- und Wasservorräte bemaß man gerade ausreichend für eine einfache Fahrt auf der vorgesehenen Strecke.

Mit den 2,30 Meter durchmessenden Treibrädern erreichten die Lokomotiven ohne unzulässig hohe Triebwerks-Drehzahlen und Kolbengeschwindigkeiten die vorgesehene

Höchstgeschwindigkeit von 175 km/h problemlos; die Lok 61 001 schaffte bei Versuchsfahrten eine maximale Geschwindigkeit von 185 km/h. Mit dem Stromlinienzug wurde aber nur Tempo 130 gefahren. Der Plandienst zwischen Dresden und Berlin wurde erfolgreich durchgeführt, die 176 Kilometer lange Strecke in nur 102 Minuten bewältigt, eine Zeit, die auf dieser Strecke bis heute (2011) trotz schnellerer Elektrolokomotiven nicht unterboten wurde.

Recht knapp bemessen war dabei die Aufenthaltszeit des Zuges in Dresden, da die Lok nicht nur an das andere Zugende umsetzen, sondern infolge der knapp bemessenen Vorräte auch noch diese erneuert werden mussten.

Bei einem Ausfall der Lok 61 001 oder der Wagengarnitur wegen planmäßiger oder außerplanmäßiger Arbeiten setzte man eine Lok der Baureihe 01 oder Baureihe 03 ein. Mit 130 km/h erreichten sie die Höchstgeschwindigkeit der 61 001 jedoch nicht.

Nach Einstellung des Zugbetriebes bei Kriegsbeginn 1939 wurde die 61 001 zum Heizdienst in Bahnbetriebswerk Berlin-Grünwald eingesetzt. Ab Dezember 1940 befand sie sich wieder in Dresden-Alttstadt im Schnellzugdienst und erhielt im November 1942 konventionelle Zug- und Stoßvorrichtungen.

Auch die auffällige Farbgebung wurde durch grau ersetzt. Später wurde auch der untere Teil der Verkleidung entfernt, damit das Triebwerk besser zugänglich war. Die Betriebsprotokolle weisen nur geringe Laufleistungen aus. Von 1943 bis Kriegsende war das Ausbesserungswerk Braunschweig für die Lok zuständig. Zwischen Juli 1945 und März 1946 legte sie rund 40.000 Kilometer vor Personenzügen zurück.



61 001

Deutsche Reichsbahn



HR2954/HR2954S



DRG

NEW

DRG, locomotiva a vapore ad alta velocità 61 001, livrea rossa, ep. II

DRG, Stromliniendampflokomotive 61 001 in roter Farbgebung, Ep. II

DRG, locomotive à vapeur à grande vitesse 61 001, livrée rouge, ép. II

DRG, locomotora de vapor de alta velocidad 61 001, decoración roja, ép. II

DRG, high-speed steam locomotive 61 001, red livery, ep. II



Fotomontage / Fotomontaje / Photomontage / Fotomontaggio



HR2955/HR2955S



DB

NEW

DB, locomotiva a vapore ad alta velocità 61 001, livrea nera con strisce, ep. III

DB, Stromliniendampflokomotive 61 001 in schwarzer Farbgebung mit Zierstreifen, Ep. III

DB, locomotive à vapeur à grande vitesse 61 001, livrée noire avec rayures, ép. III

DB, locomotora de vapor de alta velocidad 61 001, decoración negro con franjas, ép. III

DB, high-speed steam locomotive 61 001, black with stripes, ep. III



Fotomontage / Fotomontaje / Photomontage / Fotomontaggio

Vossloh DE 18



**DB/NorthRail, locomotiva diesel Vossloh DE 18, livrea grigia, ep. VI**

DB/NorthRail, Diesellokomotive Vossloh DE 18, in hellgrauer Farbgebung, Ep. VI

DB/NorthRail, locomotive diesel Vossloh DE 18, livrée grise, ép. VI

DB/NorthRail, locomotora diesel Vossloh DE 18, decoración gris, ép. VI

DB/NorthRail, diesel locomotive Vossloh DE 18, grey livery, ep. VI



© Jürgen Lorenz

Vossloh DE 18 Diesellokomotive

Bei der Vossloh DE 18 handelt es sich um die erste Lokomotive aus dem ehemaligen MaK-Werk Kiel seit der Einstellung der Produktion der DE 1002 im Jahr 1993.

Seit ihrer Markteinführung 2014 hat Vossloh mehr als 130 DE 18 Lokomotiven an Kunden in verschiedenen europäischen Ländern verkauft, die heute zuverlässig ihren Dienst sowohl im Rangier- als auch Streckenbetrieb leisten – so auch für die DB, die SNCF und seit kurzem auch die italienische FS.

Das brandneue Rivarossi-Modell in Stichpunkten:

- Vollständige Neuentwicklung
- Chassis aus Zinkdruckguss, Gehäuse aus hochwertigem, fein graviertem Kunststoff
- Fünfpoliger Hochleistungsmotor mit Schwungmassen
- Alle vier Achsen angetrieben
- Stromabnahme über alle Räder der Lokomotive
- Länge über Puffer: 195 mm

- Mindestradius: 356,5 mm
- Spitzenbeleuchtung mit der Fahrtrichtung wechselnd
- Rote Schlussleuchten mit der Fahrtrichtung wechselnd und im Digitalbetrieb separat schaltbar
- Innenbeleuchtung im Führerhaus
- Kurzkupplungskulissen beidseitig
- Kupplungsaufnahmen nach NEM 362 beidseitig
- Digitalschnittstelle nach NEM 660 (21-pin MTC)



HR2921/HR2921S



RailAdventure

NEW

RailAdventure, locomotiva diesel Vossloh DE 18, livrea grigia, ep. VI

RailAdventure, Diesellokomotive Vossloh DE 18, in grauer Farbgebung, Ep. VI

RailAdventure, locomotive diesel Vossloh DE 18, livrée grise, ép. VI

RailAdventure, locomotora diesel Vossloh DE 18, decoración gris, ép. VI

RailAdventure, diesel locomotive Vossloh DE 18, grey livery, ep. VI



© Martin Morlowsky



HR2969/HR2969S



FS Mercitalia Shunting & Terminal

NEW

FS Mercitalia S&T, locomotiva diesel Vossloh DE 18, livrea grigia, ep. VI

FS Mercitalia S&T, Diesellokomotive des Typs Vossloh DE 18 in hellgrauer Farbgebung, Ep. VI

FS Mercitalia S&T, locomotive diesel Vossloh DE 18, livrée grise, ép. VI

FS Mercitalia S&T, locomotora diesel Vossloh DE 18, decoración gris, ép. VI

FS Mercitalia S&T, diesel locomotive Vossloh DE 18, grey livery, ep. VI



DE 18 FS Mercitalia Shunting & Terminal

- Riproduzione di griglie e pannelli degli avancorpi specifici per la versione italiana della DE 18
- Cabina con porta a destra e banco di comando a sinistra in entrambi i sensi di marcia
- Captatori SSC sul ricasco del tetto della cabina
- Riproduzione del carica batterie e delle apparecchiature sottocassa specifici per la versione italiana
- Tutte le scritte di servizio coerenti con la versione riprodotta



CD Cargo, locomotiva diesel Effishunter 1000, livrea blu, nuovo numero di servizio, ep. VI

CD Cargo, Diesellokomotive des Typs Effishunter 1000, blaue Farbgebung mit neuer Betriebsnummer, Epoche VI

CD Cargo, locomotive diesel Effishunter 1000, livrée bleue, nouvelle immatriculation, ép. VI

CD Cargo, locomotora diesel Effishunter 1000, decoración azul, nueva matrícula, ép. VI

CD Cargo, diesel locomotive Effishunter 1000, blue, new running number, ep. VI

Effishunter 1000

- Riproduzione accurata di tutti i dettagli su cofani, cabina, telaio e sottocassa coerentemente differenziati in base all'unità riprodotta
- Affidabile meccanica con telaio e scatole ingranaggi in metallo, potente motore centrale a 5 poli con trasmissione a doppio albero cardanico su entrambi gli assi dei carrelli, due ruote con anello di aderenza
- Impianto elettrico con presa 21 poli NEM 660/21MTC per decoder DCC e DCC Sound, con predisposizione per altoparlante "sugar cube" 11 x 15 mm.
- Versioni "S" con decoder sonoro ed altoparlante installati di serie, con suoni specifici per il modello
- Luci bianche di testa e rosse di coda con commutazione automatica in base al senso di marcia e con possibilità di esclusione indipendente tra le due testate
- Terzo faro con comando indipendente dai fanali bassi
- Illuminazione interna in cabina, con interni fedelmente riprodotti, sedili macchinista riportati
- Carrelli estremamente realistici, con numerosi pezzi riportati per sospensione secondaria, smorzatori, cacciapietre, sabbiere, impianto frenante e coperchi boccole con relativi cavi
- Numerosi particolari riportati in metallo o plastica per il massimo realismo
- Livree e numerazioni inedite

Exhaust pipe panelling
made from photo-etchedFine detailed bogies with
metal brake discsFine detailed front with separate
and functional light housings

**HR2923/HR2923S****DINAZZANO PO/TPER****NEW****Dinazzano Po/TPER, locomotiva diesel da manovra EffiShunter 1000, livrea arancio/grigia, ep. VI**

Dinazzano Po/TPER, Diesellokomotive EffiShunter 1000, in orange/grauer Farbgebung, Ep. VI

Dinazzano Po/TPER, locomotive de manoeuvre diesel EffiShunter 1000, livrée orange/grise, ép. VI

Dinazzano Po/TPER, locomotora de maniobras diesel EffiShunter 1000, decoración naranja/gris, ép. VI

Dinazzano Po/TPER, diesel shunting locomotive EffiShunter 1000, orange/grey livery, ep. VI

EffiShunter 1000

Le locomotive diesel EffiShunter 1000 sono attualmente il prodotto di punta della CZ Loko per quanto riguarda le macchine destinate a servizi di manovra pesante, in scali ferroviari o raccordi industriali, oltre a servizi di linea.

Sono dotate di un moderno sistema di gestione della potenza e della trazione che permette un'elevata efficienza della macchina e bassi consumi, così come del sistema di segnalamento europeo ETCS, che insieme a tutte le altre caratteristiche tecniche garantiscono il certificato STI per l'interoperabilità sulle principali reti europee.

Queste macchine sono al momento operative o in ordine presso numerose imprese ferroviarie sia statali private in Italia, Repubblica Ceca, Slovenia e Norvegia, ed essendo ancora in produzione altri ordini potranno arrivare in futuro.

**HR2924/HR2924S****FNM/TRENORD****NEW****FNM/Trenord, locomotiva diesel da manovra EffiShunter 1000, livrea grigia/blu/verde, ep. VI**

FNM/Trenord, Diesellokomotive EffiShunter 1000, in grau/blau/grüner Farbgebung, Ep. VI

FNM/Trenord, locomotive de manoeuvre diesel EffiShunter 1000, livrée grise/bleue/verte, ép. VI

FNM/Trenord, locomotora de maniobras diesel EffiShunter 1000, decoración gris/azul/verde, ép. VI

FNM/Trenord, diesel locomotive EffiShunter 1000, grey/blue/green livery, ep. VI





HR2931/HR2931S



FS

FS, locomotiva diesel da manovra gruppo 245, senza corrimani laterali, livrea verde con strisce gialle, ep. IV

FS, Diesel-Rangierlokomotive Rh. 245, ohne seitliche Geländer, in grüner Lackierung mit gelbem Streifen, Ep. IV

FS, locomotive de manœuvre diesel classe 245, sans mains courantes latérales, livrée verte avec bandes jaunes, ép. IV

FS, locomotora de maniobras 245, sin pasamanos laterales, decoración verde con franjas amarillas, ép. IV

FS, diesel shunting locomotive class 245, without side handrails, green livery with yellow stripes, period IV



Fotomontage / Fotomontaje / Photomontage / Fotomontaggio



HR2932/HR2932S



Mercitalia Shunting & Terminal

Mercitalia Shunting & Terminal, locomotiva diesel da manovra gruppo 245, livrea rossa/grigio scura con strisce bianche, ep. VI

Mercitalia Shunting & Terminal, Diesel-Rangierlokomotive Rh. 245 in rot/dunkelgrauer Lackierung mit weißem Streifen, Ep. VI

Mercitalia Shunting & Terminal, locomotive de manœuvre diesel classe 245, livrée rouge/gris foncé avec bandes blanches, ép. VI

Mercitalia Shunting & Terminal, locomotora de maniobras 245, decoración roja/gris oscura con franjas blancas, ép. VI

Mercitalia Shunting & Terminal, diesel shunting locomotive class 245, red/dark grey livery with white stripes, period VI



Fotomontage / Fotomontaje / Photomontage / Fotomontaggio



DB AG, draisina KLV 53, livrea gialla con logo DB AG, ep. V

DB AG, Rottenkraftwagen KLV 53 in gelber Lackierung mit „DB AG“-Logo, Ep. V

DB AG, draine KLV 53, livree jaune avec logo DB AG, ep. V

DB AG, dresina KLV 53, decoracion amarillo con logo DB AG, ep. V

DB AG, maintenance vehicle type KLV 53, yellow livery with DB AG logo, period V



Il nuovissimo modello Rivarossi nei punti chiave:

- Vollständige Neukonstruktion
- Viele angesetzte Details
- Feine Speichenradsätze aus Metallspritzguss
- Frei beweglicher Kran am Heck des KLV
- Spitzenbeleuchtung mit der Fahrtrichtung wechselnd (nicht bei allen Modellvarianten)
- 18-polige Digitalchnittstelle nach NEM 662
- Bestellnummern, die mit „D“ enden, sind ab Werk mit Digitaldecoder ausgestattet
- Bestellnummern, die mit „S“ enden, sind ab Werk mit Sound ausgestattet
- Stromführende Magnetkupplung zwischen KLV und Anhänger



Fein detaillierte Kabine



© Wolfgang Mauser



HR2909/HR2909D/HR2909S



FS

FS, draisina KLV 53, livrea gialla RFI, ep. V-VI

FS, Rottenkraftwagen KLV 53 in gelber „RFI“-Lackierung, Ep. V-VI

FS, draisine KLV 53, livrée jaune « RFI », ép. V-VI

FS, dresina KLV 53, decoración amarillo «RFI», ép. V-VI

FS, maintenance vehicle type KLV 53, yellow "RFI" livery, period V-VI



© Luca Bergamini



HR2910/HR2910D/HR2910S



SIRTI

Draisina KLV 53, livrea gialla, "Sirti", ep. V

Rottenkraftwagen KLV 53 in gelber Lackierung, „Sirti“, Ep. V

Draisine KLV 53, livrée jaune, « Sirti », ép. V

Dresina KLV 53, decoración amarillo, «Sirti», ép. V

Maintenance vehicle type KLV 53, yellow livery, "Sirti", period V



© Rosario Palomba





HR2912/HR2912D/HR2912S



DB, draisina KLV 53, livrea gialla, ep. IV

DB, Rottenkraftwagen KLV 53 in gelber Lackierung, Ep. IV

DB, draisine KLV 53, livrée jaune, ép. IV

DB, dresina KLV 53, decoración amarillo, ép. IV

DB, maintenance vehicle type KLV 53, yellow livery, period IV



© Svetlana Linberg



HR2913/HR2913D/HR2913S



BASF, draisina KLV 53, livrea verde, ep. V

BASF, Rottenkraftwagen KLV 53 in grüner Lackierung, Ep. V

BASF, draisine KLV 53, livrée verte, ép. V

BASF, dresina KLV 53, decoración verde, ép. V

BASF, maintenance vehicle type KLV 53, green livery, period V



© Jörg Van Essen





HR2970/HR2970D



DB AG

NEW

DB AG, automotore da manovra ASF 383 001-5, livrea verde, ep. V

DB AG, ASF (Akku-Schleppfahrzeug) 383 001-5, grüne Farbgebung, Ep. V

DB AG, locomotive de manœuvre ASF 383 001-5, livrée verte, ép. V

DB AG, vehículo de maniobras ASF 383 001-5, decoración verde, ép. V

DB AG, ASF shunting device 383 001-5, green livery, ep. V



HR2971/HR2971D



DB AG

NEW

DB AG, set di 2 automotori da manovra ASF "DB Cargo Gießen", livrea rossa e blu con luci lampeggianti, ep. V-VI

DB AG, 2-tlg. Set ASF (Akku-Schleppfahrzeuge) „DB Regio Gießen“ in roter und blauer Farbgebung mit Blinklichtern, Ep. V-VI

DB AG, coffret de 2 locomotive de manœuvre ASF « DB Cargo Gießen », livrée rouge et bleue avec feux clignotants, ép. V-VI

DB AG, set de dos vehículos de maniobras ASF "DB Cargo Gießen", decoración rojo y azul, con luces de señalización, ép. V-VI

DB AG, 2-unit pack ASF shunting devices "DB Cargo Gießen", in red and blue livery with flashing lights, ep. V-VI



Con luce lampeggianti
Mit Blinklicht aus dem Dach
Avec feu clignotans
Con luz de señalización
With flashing light on the roof





E.656

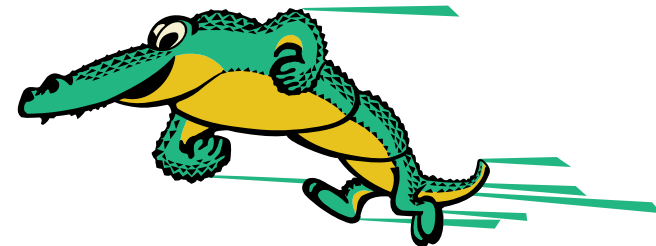

Photo: Maurizio Messa

Locomotiva Elettrica E.656

Locomotiva E.656

Le locomotive elettriche del gruppo E.656 rappresentano l'ultima evoluzione della grande famiglia di locomotive "articolate" delle FS, caratterizzate dallo schema meccanico a due semicasce poggianti su tre carrelli a due assi dotati ciascuno di due motori (doppi in questo caso), introdotto con le E636 nel 1940 e mantenuto fino alla produzione dell'ultima E656 nel 1989.

Le E656 sono state consegnate a partire dal 1975 per un totale di 461 unità, suddivise in sei serie con alcune differenze tecniche ed estetiche frutto dell'evoluzione del progetto durante la costruzione. Grazie alla loro elevata potenza (continuitiva 4200 kW, oraria 4800 kW) e alla velocità massima di 150 km/h, furono da subito destinate a rilevare i treni passeggeri a lunga percorrenza più importanti dell'epoca, treni di prestigio come alcuni TEE, ma anche treni diretti o locali con numerose fermate fino a pesanti merci al limite delle prestazioni, diventando rapidamente una delle colonne portanti del parco trazione FS.

Nel 1976 sulla rivista "Voci della Rotaia" è stato indetto un concorso per scegliere un soprannome alla E656, come già avvenuto per la E444 "Tartaruga" qualche anno prima, e la proposta vincente è risultata "Caimano". A seguito di questo, sulla fiancata sinistra delle cabine è stato applicato un adesivo raffigurante una caricatura dell'animale.

Tutte le E656 sono state consegnate nella classica livrea grigio perla e blu orientale, con fascia rosso segnale su panconi e fanali, fregio FS a "telesivore" sul frontale con "baffi" gialli attorno a questo, ma inizialmente si era pensato ad uno schema di colorazione che riprendeva la livrea delle carrozze TEE con fasce rosse su fondo beige, applicata temporaneamente in fase di costruzione alla prima unità ma non completata. A fine anni '90, come tutto il materiale rotabile FS, è stata introdotta la livrea XMPR grigio chiaro/verde con fascia blu, che su queste macchine risultava abbastanza simile alla livrea di origine seppur con colori diversi.

Con la divisionalizzazione delle FS negli anni 2000 tutte le unità sono state ripartite tra Passeggeri, Regionale e Cargo, ed a partire dal 2002 le unità di quest'ultima divisione, destinate al servizio merci, hanno ricevuto un rapporto di trasmissione più corto per incrementare le prestazioni, riducendo la velocità massima a 120 km/h; le unità così trasformate sono state inquadrate nel gruppo E655.

A partire dal 2010 sono iniziati gli accantonamenti e demolizioni, divenuti sempre più frequenti negli anni successivi, fino alla graduale dismissione dal servizio regolare dell'intero gruppo. Attualmente, grazie al lavoro di Fondazione FS, almeno 18 unità sono state preservate dalla demolizione e molte di queste, dopo ripristino funzionale ed estetico in livrea di origine, sono utilizzate regolarmente in testa a treni storici.

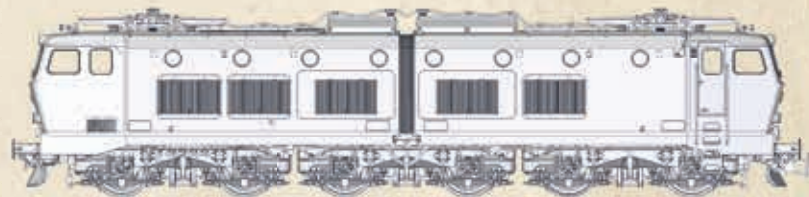

HR2965

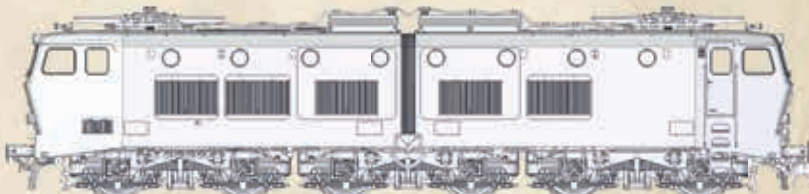

HR2966

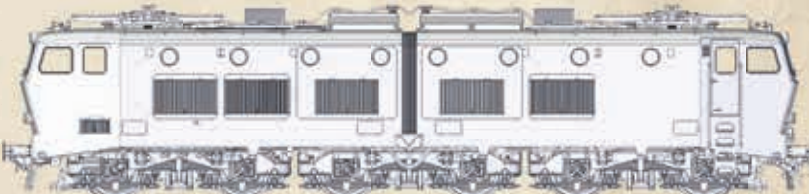

HR2967

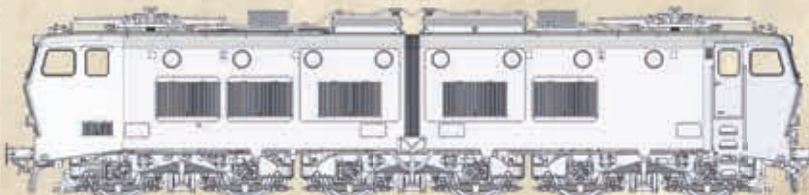

HR2968

E.656.001 - 104

2 motoalternatori.

E.656.201 - 251

Telaio irrobustito; 1 convertitore da 180 kVA 450 V 60 Hz CA.

E.656.252 - 307

Telaio irrobustito; 2 motoalternatori.

E.656.159 - 200

Telaio irrobustito; fanali maggiorati; 1 convertitore da 180 kVA 450 V 60 Hz CA, riadattato per l'interoperabilità su linee francesi (1,5 kV CC).

E.656.401 - 550

Telaio irrobustito; fanali maggiorati; 2 convertitori ARSA da 120kVA; sabbie ridotte; vetri anteriori modificati con cornice in gomma al posto del telsio in alluminio.

E.656.551 - 608

Telaio e cabina irrobustiti; fanali maggiorati; 2 convertitori ARSA da 120 kVA; sabbie ridotte ai soli assi anteriori; vetri anteriori modificati con cornice in gomma; respingenti piani con piatti rettangolari carrelli con ammortizzatori antispergoglio; asole specifiche per sollevamento in officina con cavalletti elettrici; centralina elettronica ridondata a microprocessore "Delfina" e sistema di telecomando a 78 poli con supporto per doppia trazione con una unità della stessa serie.

Serie FS	Serie	Locomotive	Anni di costruzione
I	1	E.656.001 - 104	1975 - 1979
	2	E.656.201 - 251	1978 - 1980
	3	E.656.252 - 307	1977 - 1980
	4	E.656.159 - 200	1981 - 1983
II	5	E.656.401 - 550	1984 - 1987
III	6	E.656.551 - 608	1988 - 1989

Dati tecnici

Anni di progettazione	1973-1975
Anni di costruzione	1975-1989
Anni di esercizio	Dal 1975
Quantità prodotta	461
Costruttore	Officine Casaralta, Officine Meccaniche Reggiane, SOFER, TIBB Componentistica Ercole Marelli, Ansaldo, Asgen, Italtrafo, Officine Casertane.
Lunghezza	18290 mm
Larghezza	3000 mm
Altezza	3800 mm
Interperno	5200 mm
Passo dei carrelli	2850 mm
Massa in servizio	120 t
Rodiggio	Bo'Bo'Bo'
Diametro ruote motrici	1250 mm
Rapporto di trasmissione	E.656: 28/61 E.655: 23/66.
Potenza oraria	(su 12 motori) 4800 kW
Potenza continuitiva	4200 kW
Sforzo trazione massimo	Prototipi: 249 kN
Velocità massima omologata	E.656: 160 km/h limitata a 150 km/h E.655: 120 km/h
Alimentazione	3000 V =, 1500 V =

 **Rivarossi**

**HR2965/HR2965S****FS****NEW****FS, locomotiva elettrica E.656, 1a serie, livrea sperimentale TEE, ep. IV**

FS, schwere sechssachsige Elektrolokomotive der Reihe E.656, 1. Serie in experimenteller TEE-Farbgebung, Ep. IV

FS, locomotive électrique E.656, 1^{ère} série, livrée expérimentale TEE, ép. IV

FS, locomotora eléctrica E.656, primera serie, decoración "TEE" experimental, ép. IV

FS, six-axle electric locomotive E.656, 1st series in experimental TEE livery, ep. IV**E.656**

- Nuovi stampi per cassa, carrelli e relative parti riportate, con riproduzione accurata di tutte le caratteristiche tipiche delle diverse serie costruttive su frontali, fiancate e tetto.
- Affidabile meccanica con telaio articolato e scatole ingranaggi in metallo, potente motore centrale a 5 poli con trasmissione a doppio albero cardanico su entrambi gli assi dei carrelli di estremità, due ruote con anello di aderenza.
- Impianto elettrico interamente nuovo, con presa 21 poli NEM 660/21MTC per decoder DCC e DCC Sound, con predisposizione per altoparlante "sugar cube" 11 x 15 mm.
- Versioni "S" con decoder sonoro Hornby HM7000 ed altoparlante installati di serie, con suoni specifici per il modello.
- Luci bianche di testa e rosse di coda con commutazione automatica in base al senso di marcia e con possibilità di esclusione indipendente tra le due cabine. Posizione dei fanali rossi coerentemente differenziata in base all'unità riprodotta.
- Terzo faro con comando indipendente dai fanali bassi.
- Illuminazione interna di entrambe le cabine e del corridoio laterale con comando indipendente.
- Possibilità di installazione del pattino centrale per funzionamento su sistemi a 3 rotaie, con commutazione del sistema tramite jumper sul circuito stampato.

HM DCCFotomontage / Fotomontaje / Photomontage / Fotomontaggio
L'immagine mostra il modello in scala N / Abb. zeigt Spur-N-Modell / Picture shows N-scale model**HR2966 /HR2966S****FS****NEW****FS, locomotiva elettrica E.656, 2a serie, livrea di origine, con gocciolatoio, ep. IV**

FS, schwere sechssachsige Elektrolokomotive der Reihe E.656, 2. Serie in Originalfarbgebung, mit Regenrinne, Ep. IV

FS, locomotive électrique E.656, 2^e série, livrée d'origine, avec gouttière, ép. IV

FS, locomotora eléctrica E.656, segunda serie, con vierteaguas, decoración original 2, ép. IV

FS, six-axle electric locomotive E.656, 2nd series original livery, with gutter, ep. IV

E.656

- Portagancio NEM 362 con timone di allontanamento per aggancio corto su entrambe le testate, con possibilità di smontaggio del portagancio per allestire i frontali con tutti i particolari realistici.
- Riproduzione accurata dei pantografi Tipo 52 FS interamente in metallo con possibilità di captazione di corrente; posizione di riposo estremamente piatta e realistica.
- Riproduzione accurata del tetto con numerose parti riportate, griglie dei praticabili in fotoincisione conformi al vero, condizionatori completi di tubazioni dove presenti.
- Interni cabina e parete corridoio fedelmente riprodotti, con parti riportate e decorazioni differenziate tra cabine A e B come al vero.
- Carrelli Um1250 estremamente realistici, con sospensione secondaria e trave oscillante come pezzi riportati; con o senza riproduzione degli smorzatori antiserpeggio e con 4 o 12 sabbie, a seconda del periodo di ambientazione; riproduzione dei captatori della Ripetizione Segnali in cabina con boe SCMT dove presenti.
- Numerosi particolari riportati in metallo o plastica per il massimo realismo.

HM DCCFotomontage / Fotomontaje / Photomontage / Fotomontaggio
L'immagine mostra il modello in scala N / Abb. zeigt Spur-N-Modell / Picture shows N-scale model



HR2967/HR2967S



NEW

FS, locomotiva elettrica E.655, 2a serie, livrea XMPR, ep. V-VI

FS, schwere sechssachsige Elektrolokomotive der Reihe E.655, 2. Serie in XMPR-Farbgebung, Ep. V-VI

FS, locomotive électrique E.655, 2^{ème} série, livrée XMPR, ép. V-VI

FS, locomotora eléctrica E.655, segunda serie, decoración "XMPR", ép. V-VI

FS, six-axle electric locomotive E.655, 2nd series XMPR livery, ep. V-VI



Fotomontage / Fotomontaje / Photomontage / Fotomontaggio
L'immagine mostra il modello in scala N / Abb. zeigt Spur-N-Modell / Picture shows N-scale model



HR2968/HR2968S



NEW

FS, locomotiva elettrica E.656, 4a serie, livrea di origine, senza gocciolatoio, con smorzatori, ep. V

FS, schwere sechssachsige Elektrolokomotive der Reihe E.656, 4. Serie in OriginalFarbgebung, ohne Regenrinne, mit Dämpfern, Ep. V

FS, locomotive électrique E.656, 4^{ème} série, livrée d'origine, sans gouttière et avec ventilateurs, ép. V

FS, locomotora eléctrica E.656, cuarta serie, sin vierteaguas y con amortiguadores, decoración original, ép. V

FS, six-axle electric locomotive E.656, 4th series original livery, without gutter, with dampers, ep. V



Fotomontage / Fotomontaje / Photomontage / Fotomontaggio
L'immagine mostra il modello in scala N / Abb. zeigt Spur-N-Modell / Picture shows N-scale model

E.645



© Donato Rossi

Il nuovissimo modello Rivarossi nei punti chiave:

- Nuovi stampi per le carrozzerie, con riproduzione accurata di tutte le caratteristiche tipiche delle macchine di prima serie nell'ambientazione da fine anni '80, con modifiche ai gocciolatoi delle cabine, pannelli laterali, fregio FS frontale in diverse posizioni a seconda dell'unità riprodotta, serpentina sul ricasco del tetto, scalette e corrimani coerenti con l'epoca
- Collaudata ed affidabile meccanica con telaio articolato e scatole ingranaggi in metallo, potente motore centrale a 5 poli con trasmissione a doppio albero cardanico su entrambi gli assi dei carrelli di estremità, due ruote con anello di aderenza
- Nuovo impianto elettrico con presa 21 poli NEM 660/21MTC per decoder DCC e DCC Sound, con predisposizione per altoparlante circolare da 23 mm oppure di tipo "sugar cube" da 11x15 mm
- Versioni "S" con decoder sonoro ESU Loksound V5 ed altoparlante installati di serie, con suoni specifici per il modello
- Luci bianche di testa e rosse di coda con commutazione automatica in base al senso di marcia e con possibilità di esclusione indipendente tra le due cabine, sia in analogico (tramite DIP SWITCH sulla PCB principale) che in digitale (tramite decoder)
- Possibilità di installazione del pattino centrale per funzionamento su sistemi a 3 rotaie, con commutazione del sistema tramite jumper sul circuito stampato
- Portagancio NEM 362 con timone di allontanamento per aggancio corto su entrambe le testate, con possibilità di smontaggio del portagancio per allestire i frontali con tutti i particolari realistici
- Riproduzione accurata dei pantografi Tipo 52 o 42U FS (a seconda dell'unità riprodotta) interamente in metallo con possibilità di captazione di corrente; posizione di riposo estremamente piatta e realistica
- Carrelli U1250 con 4 o 12 sabbie, a seconda del periodo di ambientazione; riproduzione dei cacciapietre di origine oppure dotati di captatori della Ripetizione Segnali, a seconda della versione riprodotta
- Numerosi particolari riportati in metallo o plastica per il massimo realismo, tra cui nuovi supporti reggibattenti sui panconi in fotoincisione installati in fabbrica



HR2934/HR2934S



FS, locomotiva elettrica E.645, 1a serie, livrea castano/Isabella con logo FS semplificato, pantografi 42U, ep. IV-V

FS, Elektrolokomotive E.645, 1. Serie, castano/Isabella-Lackierung mit vereinfachtem FS-Logo, Stromabnehmer 42U, ep. IV-V

FS, locomotive électrique E.645, 1^{ère} série, livrée castano/Isabella avec logo FS simplifié, pantographes 42U, ép. IV-V

FS, locomotora eléctrica E.645, primera serie, decoración castano/Isabella con logo FS simplificado, pantógrafos 42U, ép. IV-V

FS, electric locomotive E.645, 1st series, castano/Isabella livery with simplified FS logo, pantographs 42U, period IV-V



- Livrea castano/isabella con carrelli neri
- Fregio FS a scudo senza baffi in posizione alta, con sfondo castano
- Cabine con gocciolatoio lato macchinista ridotto e senza gocciolatoio frontale
- Epoca IVb-Va (fine anni '80/inizio '90)
- 12 sabbie sui carrelli
- Serpentina su ricasco tetto semicassa B
- Cacciapietre con captatori della Ripetizione Segnali
- Pantografi Tipo 42U FS con strisciante curvo
- Vomeri a lame curve con strisce gialle/neri

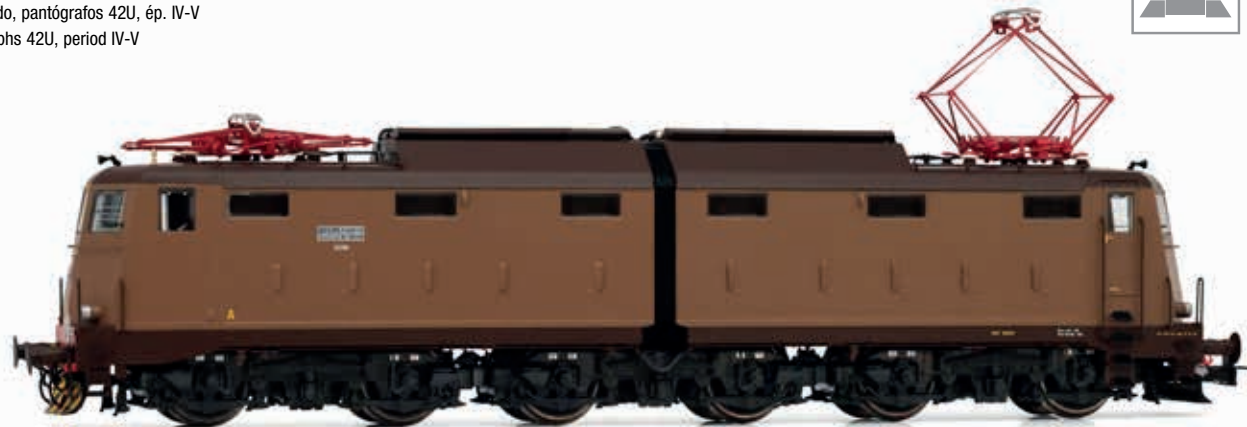

**HR2935/HR2935S****FS****FS, locomotiva elettrica E.645, 1a serie, livrea Isabella con logo FS rosso semplificato, pantografi 52, ep. V**

FS, Elektrolokomotive E.645, 1. Serie, Isabella-Lackierung mit vereinfachtem FS-Logo, Stromabnehmer 52, ep. V

FS, locomotive électrique E.645, 1^{ère} série, livrée Isabella avec logo rouge simplifié FS, pantographe 52, ep. V

FS, locomotora eléctrica E.645, primera serie, decoración Isabella con logo FS rojo simplificado, pantógrafos 52, ép. V

FS, electric locomotive E.645, 1st series, Isabella livery with simplified red FS logo, pantographs 52, period V



- Livrea isabella con carrelli neri
- Fregio FS a scudo senza baffi in posizione bassa, con sfondo rosso
- Cabine con gocciolatoio lato macchinista ridotto e senza gocciolatoio frontale
- Epoca V (anni '90/2000)
- 4 sabbie sui carrelli
- Serpentina su ricasco tetto semicassa B
- Sportellino dispositivo "Willy Vogel" su semicassa B
- Cacciapietre con captatori della Ripetizione Segnali
- Pantografi Tipo 52 FS con strisciante piano
- Vomeri a lame curve con strisce gialle/neri

**HR2933/HR2933S****FS****FS, locomotiva elettrica E.645, 1a serie, livrea castano/Isabella con logo FS semplificato, pantografi 52, ep. IV-V**

FS, Elektrolokomotive E.645, 1. Serie, castano/Isabella-Lackierung mit vereinfachtem FS-Logo, Stromabnehmer 52, Ep. IV-V

FS, locomotive électrique E.645, 1^{ère} série, livrée castano/Isabella avec logo FS simplifié, pantographes 52, ép. IV-V

FS, locomotora eléctrica E.645, primera serie, decoración castano/Isabella con logo FS simplificado, pantógrafos 52, ép. IV-V

FS, electric locomotive E.645, 1st series, castano/Isabella livery with simplified FS logo, pantographs 52, period IV-V



- Livrea castano/isabella con carrelli neri
- Fregio FS a scudo senza baffi in posizione alta, con sfondo castano
- Cabine con gocciolatoio lato macchinista ridotto e senza gocciolatoio frontale
- Epoca IVb-Va (fine anni '80/inizio '90)
- 12 sabbie sui carrelli
- Serpentina su ricasco tetto semicassa B
- Cacciapietre di origine
- Pantografi Tipo 52 FS con strisciante curvo
- Vomeri a lame curve con strisce gialle/neri





E.636

Locomotiva E.636

Nel 1938 l'ingegner Alfredo d'Arbela e la sua équipe presentarono un nuovo tipo di rotabile. La costruzione della prima serie di dieci unità, numerate E.636.001-010, fu ordinata il 1° settembre 1938 e le macchine furono consegnate tra il maggio ed il settembre 1940.

Le nasciture E.636 concettualmente erano nient'altro che una versione meccanicamente aggiornata delle vecchie E.626, e ne mantenevano alcuni problemi di progettazione: qualche problema di rumorosità causato dal sistema di trasmissione non impedì a questo nuovo gruppo di affermarsi. Vennero studiati due diversi rapporti di trasmissione: uno più corto (21/65) per i tratti in pendenza o per i treni pesanti, con velocità massima di 95 km/h (poi accresciuta a 105 nel 1948) ed uno più lungo (28/65) con velocità massima di 120 km/h.

Il primo esemplare, la E.636.001, entrò in servizio nel maggio 1940, e durante la guerra altre 107 unità furono consegnate fino al 1943 da diverse industrie quali Breda, OM, CGE, Officine Meccaniche Reggiane, Magneti Marelli e Officine Ferroviarie Savigliano. Il gruppo E.636 è stato prodotto in tre serie di locomotive. La prima serie (001 - 108) costruita dal 1940 al 1942. La seconda serie (109 - 243) costruita dal 1952 al 1956. E la terza serie (244 - 469), costruita dal 1957 al 1962.



HR2936/HR2936S



FS, locomotiva elettrica E.636, 3a serie, senza gocciolatoi frontali, livrea castano/Isabella, ep. IV-V

FS, Elektrolokomotive E.636, 3. Bauserie ohne Regenrinnen in brauner Castano/Isabella-Lackierung, Ep. IV-V

FS, locomotive électrique E.636, 3ème série, livrée castano/Isabella, sans gouttières, ép. IV-V

FS, locomotora eléctrica E.636, tercera serie, sin vierteaguas, decoración castano/Isabella, ép. IV-V

FS, electric locomotive E.636, 3rd series, without gutters, castano/Isabella livery, period IV-V



HR2937/HR2937S



FS, locomotiva elettrica E.636, 3a serie, senza gocciolatoi frontali, livrea Isabella, ep. V

FS, Elektrolokomotive E.636, 3. Bauserie ohne Regenrinnen in Isabella-Lackierung, Ep. V

FS, locomotive électrique E.636, 3ème série, livrée Isabella, sans gouttières, ép. V

FS, locomotora eléctrica E.636, tercera serie, sin vierteaguas, decoración Isabella, ép. V

FS, electric locomotive E.636, 3rd series, without gutters, Isabella livery, period V





HR2941/HR2941S



DR

NEW

DR, locomotiva elettrica E251 001, livrea verde con carrelli neri, ep. III

DR, schwere sechssachsige Elektrolokomotive E251 001 in grüner Farbgebung mit schwarzen Drehgestellen, Ep. III

DR, locomotive électrique E251 001, livrée verte avec bogies noirs, ép. III

DR, locomotora eléctrica E251 001, decoración verde con bogies negros, ép. III

DR, six-axle electric locomotive E251 001, green livery with black bogies, ep. III



HR2942/HR2942S



DR

NEW

DR, locomotiva elettrica 251 015-4, livrea verde con carrelli rossi, ep. IV

DR, schwere sechssachsige Elektrolokomotive 251 015-4 in grüner Farbgebung mit roten Drehgestellen, Ep. IV

DR, locomotive électrique 251 015-4, livrée verte avec bogies rouges, ép. IV

DR, locomotora eléctrica 251 015-4, decoración verde con bogies rojos, ép. IV

DR, six-axle electric locomotive 251 015-4, green livery with red bogies, ep. IV





HR2961/HR2961S



DB AG

NEW

DB AG, locomotiva elettrica, BR 171, livrea rosso traffico, ep. V

DB AG, schwere sechssachsige Elektrolokomotive der Baureihe 171 in verkehrsroter Farbgebung, Ep. V

DB AG, locomotive électrique, BR 171, livrée rouge trafic, ép. V

DB AG, locomotora eléctrica BR 171, decoración rojo tráfico, ép. V

DB AG, heavy six-axle electric locomotive, BR 171, traffic red livery, ep. V



Das neue Rivarossi-Modell im Detail

- Chassis aus Metalldruckguss
- Kurzkupplungskinematik
- 21-polige Digitalchnittstelle (MTC)
- mittlere Achse im Drehgestell federnd gelagert
- 4 Haftreifen für maximale Zugkraft
- 2 Schwungmassen
- funktionsfähige Stromabnehmer
- Zurüstteile für den Einsatz als Vitrinenmodell
- Dreilicht-Spitzensignal und rotes Schlusslicht mit der Fahrtrichtung wechselnd, Rangierlicht im Digitalbetrieb schaltbar
- Vorbereitet für den Einbau eines Sound-Decoders
- Individuelle Nachbildung der Dachlaufstege (Holz bzw. Metall)
- Individuelle Nachbildung der Signalhörner (verschiedene Bauarten)
- Individuelle Nachbildung der Bremslüfter, je nach Loknummer und Bauzustand
- Individuelle Nachbildung der Sifa, je nach Loknummer und Bauzustand



© Roland Lange



HR2938/HR2938S



ÖBB

ÖBB, locomotiva elettrica 1040 003, livrea rosso vermiglio con una fascia decorativa, ventola di origine, tetto basso, predellini frontali, ep. V

ÖBB, Elektrolokomotive 1040 003, blutorange Lackierung mit Zierlinie, Ursprungslüfter, Flachdach, Trittstufen, Ep. V

ÖBB, locomotive électrique 1040 003, livrée rouge vermillon avec une bande décorative, ventilateur d'origine, toit bas et marchepieds avant, ép. V

ÖBB, locomotora eléctrica 1040 003, decoración rojo bermellón con franja, ventilador de origen, techo bajo y estribos frontales, ép. V

ÖBB, electric locomotive 1040 003, vermillion livery with one decoration line, old fan, low roof, steps on front, ep. V





HR2939/HR2939S



ÖBB

ÖBB, locomotiva elettrica 1040.10, nuove griglie di ventilazione laterali, livrea verde, con reostato di frenatura sul tetto, ep. IV

ÖBB, Elektrolokomotive 1040.10, neue seitliche Lüftungsgitter, grüne Lackierung, mit Bremswiderständen auf dem Dach, Ep. IV

ÖBB, locomotive électrique 1040.10, livrée verte avec grilles de ventilation modernes et équipement de freinage rhéostatique sur le toit, ép. IV

ÖBB, locomotora eléctrica 1040.10, decoración verde con rejillas de ventilación modernas y freno reostático en el techo, ép. IV

ÖBB, electric locomotive 1040.10, new lateral air vents, green livery, with brake resistors on the roof, ep. IV



HR2940/HR2940S



ÖBB

ÖBB, locomotiva elettrica 1040 007-5, nuove griglie di ventilazione laterali, livrea rosso vermiglio con tre fasce decorative, tetto basso, predellini frontali, ep. V

ÖBB, Elektrolokomotive 1040 007-5, neue seitliche Lüftungsgitter, blutorange Lackierung mit drei Zierlinien, niedriges Dach, Rangiertritte vorn und hinten, Ep. V

ÖBB, locomotive électrique 1040 007-5, livrée rouge vermillon avec trois bandes décoratives, grilles de ventilation modernes, toit bas et marchepieds avant, ép. V

ÖBB, locomotora eléctrica 1040 007-5, decoración rojo bermellón con tres franjas, con rejillas de ventilación laterales modernas, techo bajo y estribos frontales, ép. V

ÖBB, electric locomotive 1040 007-5, new lateral air vents, vermillion livery with three decoration lines, low roof, steps on front, ep. V



60 Jahre Re 4/4^{II} der BLS

GIPFELSTÜMER



Photo: Staatarchiv des Kantons Bern



Anlässlich des 60. Jubiläums wird dieses Modell in einer attraktiven Sonderverpackung geliefert.

Der elektrische Universallokomotive der ehemaligen Bern-Lötschberg-Simplon-Bahn

Die BLS Ae 4/4II wurde von 1964 bis 1983 als Universallokomotive mit guter Bergleistung beschafft, um die Züge mit höheren Geschwindigkeiten befördern zu können und um die Lokomotiven der Gründungsjahre abzulösen.

Aufgrund der sehr erfolgreichen Konstruktion der Ae 4/4 der BLS, der ersten laufachslosen Hochleistungslokomotive der Welt, leiteten die BLS und SLM die Neuentwicklung von dieser Reihe ab. Das ist auch an der Kastenform eindeutig zu erkennen: Die Anordnung der Einstiege an der Lokfront wurde von der Ae 4/4 übernommen. Das Fahrgestell ist ähnlich demjenigen der SBB Re 4/4II. Doch da hören die Gemeinsamkeiten zu dieser auch sehr erfolgreichen Baureihe auf. So wird die Kraft mit einer anders konstruierten Tiefzulanlenkung und Seilzug auf die Schienen gebracht. Statt Sandereinrichtungen besitzt die Lok Schienendüsen. Bei vielen Versuchen und Vergleichen mit z. T. ausländischen Lokomotiven stellt die Re 4/4 noch heute ihre enorme Leistungsfähigkeit am Berg unter Beweis. Einen 630-Tonnen-Zug kann die Lok auf einer 26-%-Steigung mit 80 km/h befördern. Die Stundenzugkraft beträgt 226 kN bei 77,5 km/h.

Die ersten fünf Maschinen waren bei Ablieferung nur für 125 km/h zugelassen und wurden dementsprechend Ae 4/4II 261–265 bezeichnet. 1969 wurden sie nach Änderung der Kastenabstützung auf Schraubenfedern und ausgedehnten Versuchsfahrten für die Reihe R zugelassen und die Höchstgeschwindigkeit auf 140 km/h hinaufgesetzt. Seither tragen die Lokomotiven die Bezeichnung Re 4/4 161–165.

HR2958/HR2958S/HR2958ACS



BLS

NEW

BLS, locomotiva elettrica a 4 assi Re 4/4 167 "Ausserberg", livrea marrone, ep. IV-V

BLS, vierachsige elektrische Mehrzwecklokomotive Re 4/4 167 „Ausserberg“, braun, Ep. IV-V

BLS, locomotive électrique à 4 essieux Re 4/4 167 « Ausserberg », livrée marron, ép. IV-V

BLS, locomotora eléctrica Re 4/4 167 "Ausserberg" corta, edición aniversario BLS, ép. IV-V

BLS, 4-axle electric locomotive Re 4/4 167 "Ausserberg", brown, epoch IV-V



Fotomontage / Fotomontaje / Photomontage / Fotomontaggio





HR2959/HR2959S/HR2959ACS



BLS

NEW

BLS, locomotiva elettrica a 4 assi Re 4/4 181 "Interlaken", livrea marrone, ep. IV

BLS, vierachsige elektrische Mehrzwecklokomotive Re 4/4 181 „Interlaken“, braun, Ep. IV

BLS, locomotive électrique à 4 essieux Re 4/4 181 « Interlaken », livrée marron, ép. IV

BLS, locomotora eléctrica Re 4/4 181 "Interlaken" larga, ép. IV

BLS, 4-axle electric locomotive Re 4/4 181 "Interlaken », brown, epoch IV



Fotomontage / Fotomontaje / Photomontage / Fotomontaggio



HR2960/HR2960S/HR2960ACS



BLS

NEW

BLS, locomotiva elettrica a 4 assi Re 4/4 191 "Reichenbach", con pantografo monobraccio, livrea marrone, ep. IV-V

BLS, vierachsige elektrische Mehrzwecklokomotive Re 4/4 191 „Reichenbach“, mit Einholmstromabnehmer, braun, Ep. IV-V

BLS, locomotive électrique à 4 essieux Re 4/4 191 « Reichenbach », avec pantographe unijambiste, livrée marron, ép. IV-V

BLS, locomotora eléctrica Re 4/4 191 "Reichenbach" larga con pantógrafo de brazo, ép. IV-V

BLS, 4-axle electric locomotive Re 4/4 191 "Reichenbach », with single-arm pantograph, brown, epoch IV-V



Fotomontage / Fotomontaje / Photomontage / Fotomontaggio



HR2943/HR2943HM



NEW

Tram DUEWAG GT8, versione Graz, livrea blu/beige, ep. IV-V

Straßenbahn, Typ DUEWAG GT8, Version Graz in grün/beiger Lackierung, Ep. IV-V

Tram DUEWAG GT8, version Graz, livrée bleue/beige, ép. IV-V

Tranvia DUEWAG GT8, versión Graz, decoración azul/beige, ép. IV-V

DUEWAG tram GT8, Graz version, blue/beige livery, period IV-V



HR2944/HR2944HM



NEW

Tram N8, versione Dortmund, livrea marrone/beige, ep. IV

Straßenbahn, Typ N8, Version Dortmund in braun/beiger Lackierung, Ep. IV

Tram N8, version Dortmund, livrée marron/beige, ép. IV

Tranvia N8, versión Dortmund, decoración marrón/beige, ép. IV

Tram N8, Dortmund version, brown/beige livery, period IV





HR2945/HR2945HM



NEW

Tram M6, versione Norimberga, livrea rossa/bianca, ep. IV-V

Straßenbahn, Typ M6, Version Nürnberg in rot/weißer Lackierung, Ep. IV-V

Tram M6, version Nuremberg, livrée rouge/blanche, ép. IV-V

Tranvia M6, versión Nüremberg, decoración roja/blanca, ép. IV-V

Tram M6, Nuremberg version, red/white livery, period IV-V

Die ersten Rivarossi-Modelle mit HM7000-Bluetooth®-Digitaldecodern

Die Digitalversionen unserer neuen Rivarossi-Straßenbahnmodelle HR2943HM, HR2944HM, HR2945HM und HR2861HM sind die ersten Rivarossi-Modelle, die mit den neuen Hornby HM7000 Bluetooth®-Decodern ausgestattet sind. Diese können über Ihr Smartphone oder Tablet gesteuert werden, ohne dass Sie dazu eine Digitalzentrale benötigen. Mehr über alle revolutionären Funktionen des neuen Systems erfahren Sie hier: <https://de.rivarossi.com/hm7000>



HR2861/HR2861HM



Tram DUEWAG GT6 Heidelberger, livrea "Coca Cola", ep. IV-V

Straßenbahn, Typ DUEWAG GT6, Version Heidelberger in „Coca Cola“-Lackierung, Ep. IV-V

Tram DUEWAG GT6 Heidelberger, livrée « Coca Cola », ép. IV-V

Tranvia DUEWAG GT6 Heidelberger, decoración «Coca Cola», ép. IV-V

DUEWAG tram GT6 Heidelberger, "Coca Cola" livery, period IV-V

First Rivarossi models with HM7000 Bluetooth® digital decoders

The digital versions of our new Rivarossi tram models HR2943HM, HR2944HM, HR2945HM and HR2861HM are the first Rivarossi models to come equipped with the new Hornby HM7000 Bluetooth® decoders that can be controlled via your smartphone or tablet without the need of a digital central. More about all the revolutionary features of new system here: <https://uk.rivarossi.com/hm7000>



Fotomontage / Fotomontaje / Photomontage / Fotomontaggio

FS ETR 460



ETR 460

Gli ETR.460 sono caratterizzati dagli attuatori dell'assetto variabile posti in posizione quasi orizzontale fra cassa e carrello, ottenendo quindi un minor ingombro di tali dispositivi rispetto a convogli del passato che li prevedevano in posizione verticale.

Come gli ETR-450, inizialmente anche gli ETR-460 erano stati concepiti come treni di sola I classe, ma nell'estate 1993, quando era già iniziata la costruzione dei primi esemplari, le FS decisero di includere anche il servizio di II classe, rendendo quindi necessaria una parziale riprogettazione che portò a un ritardo nella consegna dei primi treni: il 12 Giugno 1994 il primo convoglio uscì dai cancelli della FIAT Ferroviaria nella composizione provvisoria di soli 6 elementi (due unità di trazione) di sola I classe, cosa che avvenne anche per i successivi due treni. Nel corso dei mesi seguenti le composizioni vennero poi riorganizzate e completate con tutti gli elementi di II classe e le carrozze Bar/Ristoro. Gli ETR-460 debuttarono in servizio nei primi mesi del 1995, assumendo quindi il ruolo di rotabili di punta delle FS; dapprima sostituirono gradualmente gli ETR-450 sulla relazione Milano-Roma, dopodiché, man mano che vennero completate le consegne di tutti e dieci i convogli (numerati da 21 a 30), vennero inseriti anche sulle relazioni tra Torino e Venezia e tra Torino, Genova e Roma. A partire dall'autunno 1996 tuttavia persero il primato sulla relazione Milano-Roma, venendo progressivamente sostituiti dai nuovi ETR-500 e venendo quindi dirottati su altre relazioni.



HR2962/HR2962S



FS

NEW

FS, set di 4 unità, treno ad alta velocità ad assetto variabile ETR 460, livrea "Frecciabianca", ep. VI

FS, Hochgeschwindigkeitszug mit Neigetechnik der Reihe ETR 460 „Frecciabianca“, 4-tlg. Grundset, Ep. VI

FS, coffret de 4 unités de train pendulaire à grande vitesse ETR 460 « Frecciabianca », ép. VI

FS, automotor eléctrico ETR 460 "Frecciabianca", set base de 4 unidades, ép. VI

FS, tilting high-speed train type ETR 460 "Frecciabianca", 4-unit base set, ep. VI



HR3024



FS

NEW

FS, set di 5 carrozze intermedie per il treno ad alta velocità ad assetto variabile ETR 460, livrea "Frecciabianca", ep. VI

FS, 5-tlg. Set Zwischenwagen für Hochgeschwindigkeitszug mit Neigetechnik der Reihe ETR 460 „Frecciabianca“, Ep. VI

FS, coffret de 5 voitures intermédiaires du train pendulaire à grande vitesse ETR 460 « Frecciabianca », ép. VI

FS, set de 5 coches intermedios del automotor ETR 460 "Frecciabianca", ép. VI

FS, tilting high-speed train type ETR 460 "Frecciabianca", 5-unit pack intermediate coaches, ep. VI



Archivio Rivarossi

**HR2963/HR2963S****Cisalpino****NEW****Cisalpino, set base di 4 unità, treno ad alta velocità ad assetto variabile ETR 470, livrea d'origine con fascia anteriore rossa, ep. V**

Cisalpino, Hochgeschwindigkeitszug mit Neigetechnik der Reihe ETR 470, 4-tlg. Grundset, Ep. V

Cisalpino, coffret de base de 4 unités, train pendulaire à grande vitesse ETR 470, livrée d'origine avec bande frontale rouge, ép. V

Cisalpino, automor eléctrico ETR 470, decoración original con franja roja frontal, set base de 4 unidades, ép. V

Cisalpino, tilting high-speed train type ETR 470 in original livery with red front stripe, 4-unit base set, ep. V

**HR3025****Cisalpino****NEW****Cisalpino, set di 5 carrozze intermedie per il treno ad alta velocità ad assetto variabile ETR 470, livrea originale, ep. V**

Cisalpino, 5-tlg. Set Zwischenwagen für Hochgeschwindigkeitszug mit Neigetechnik der Reihe ETR 470, Ep. V

Cisalpino, coffret de 5 voitures intermédiaires supplémentaires, train pendulaire à grande vitesse ETR 470, livrée d'origine, ép. V

Cisalpino, set de 5 coches intermedios del automotor ETR 470, decoración original, ép. V

Cisalpino, tilting high-speed train type ETR 470 in original livery, 5-unit pack additional intermediate coaches, ep. V



Enrique Dopico



HR2964/HR2964S



SBB CFF FFS

NEW

FFS, set di 3 unità, treno ad alta velocità ad assetto variabile ETR 470, livrea argento con strisce blu, ep. V

SBB, Hochgeschwindigkeitszug mit Neigetechnik der Reihe ETR 470, 4-tlg. Grundset, Ep. V

FFS, coffret de 3 unités, train pendulaire à grande vitesse ETR 470, livrée argentée avec bande bleue, ép. V

SBB, automotor eléctrico ETR 470, decoración plata con franja azul, set base de 4 unidades, ép. V

SBB, tilting high-speed train type ETR 470 silver livery with blue stripe, 4-unit base set, ep. V



HR3026



SBB CFF FFS

NEW

FFS, set di 5 carrozze intermedie per il treno ad alta velocità ad assetto variabile ETR 470, livrea argento con striscia blu, ep. V

SBB, 5-tlg. Set Zwischenwagen für Hochgeschwindigkeitszug mit Neigetechnik der Reihe ETR 470, Ep. V

FFS, coffret de 5 voitures intermédiaires supplémentaires pour le train pendulaire à grande vitesse ETR 470, livrée argentée avec bande bleue, ép. V

SBB, set de 5 coches intermedios del automotor ETR 470, decoración plata con franja azul, ép. V

SBB, tilting high-speed train type ETR 470 in silver livery with blue stripe, 5-unit pack additional intermediate coaches, ep. V



Enrique Dopico



EDELWEISS PULLMAN EXPRESS

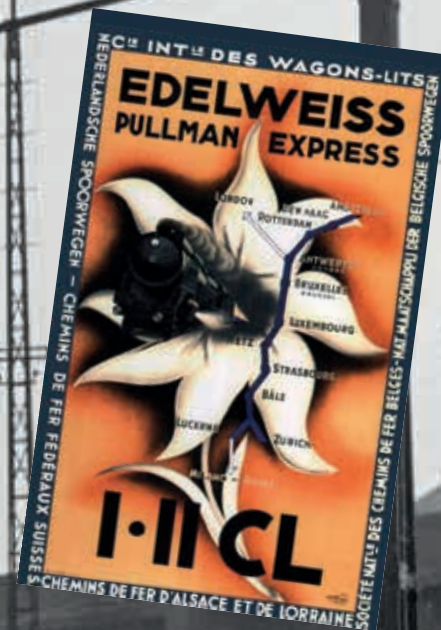

Der Edelweiss Pullman Express

Der „Edelweiss“ verkehrte von 1928 bis 1979 mit kriegsbedingter Unterbrechung als Zugpaar zwischen der Schweiz und den Niederlanden über das Elsass und Luxemburg. Bis 1939 verkehrte der Zug als von der Internationalen Schlafwagengesellschaft CIWL betriebener Luxuszug von Amsterdam nach Basel und zweitweise auch Luzern. Nach dem Zweiten Weltkrieg zunächst als normaler Schnellzug geführt, wurde der Edelweiss ab 1957 eines der ersten Zugpaare des neuen Trans-Europ-Express-Systems (TEE). 1979 wurde er eingestellt.

Wenig bekannt ist, dass der Edelweiss Pullman Express der CIWL damals ein direkter Konkurrent des damaligen Rheingolds war. Bis zum Kriegsausbruch verkehrte der Zug südlich von Basel aber auch zusammen mit den Kurswagen des Rheingolds.

Die CIWL setzte im „Edelweiss“ bis 1939 als Fahrzeuge ausschließlich ihre ab 1925 beschafften Pullmanwagen ein. Da diese mit Küche und Am-Platz-Service ausgestattet waren, gab es in der Regel keinen gesonderten Speisewagen und darüber hinaus nur Gepäckwagen. Als Tageszug führte der Edelweiss keine Schlafwagen mit. Im Regelfall bestand der „Edelweiss“ aus mindestens vier Pullmanwagen sowie zwei Gepäckwagen.

Pullman-Edelweiss-Zug Bahnhof Basel. 1937.
© Wagons-Lits Diffusion



HR4390



CIWL

NEW

CIWL, set di 3 unità "Edelweiss Pullman Express", set 1/2 (DD3, VPC Côte d'Azur + VP Étoile du Nord), ep. II

CIWL, 3-tlg. Zugset „Edelweiss Pullman Express“, Set 1/2 (DD3, VPC Côte d'Azur + VP Étoile du Nord), Ep. II

CIWL, coffret de 3 unités « Edelweiss Pullman Express », set 1/2 (DD3, VPC Côte d'Azur + VP Étoile du Nord), ép. II

CIWL, primer set de 3 coches "Edelweiss Pullman Express", compuesto de un coche DD3, un VPC "Côte d'Azur" y un VP "Étoile du Nord", ép. II

CIWL, 3-unit pack "Edelweiss Pullman Express", train set 1/2 (DD3, VPC Côte d'Azur + VP Étoile du Nord), ep. II

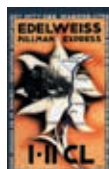

Vetture dotate di illuminazione interna con touch control per attivare e variare l'intensità

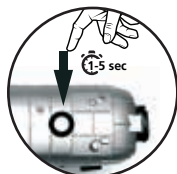

HR4391



CIWL

NEW

CIWL, set di 3 unità "Edelweiss Pullman Express", set 2/2 (DD3, VPC Flèche d'Or + VP Étoile du Nord), ep. II

CIWL, 3-tlg. Zugset „Edelweiss Pullman Express“, Set 2/2 (DD3, VPC Flèche d'Or + VP Étoile du Nord), Ep. II

CIWL, coffret de 3 unités « Edelweiss Pullman Express », set 2/2 (DD3, VPC Flèche d'Or + VP Étoile du Nord), ép. II

CIWL, segundo set de 3 coches "Edelweiss Pullman Express", compuesto de un coche DD3, un VPC "Flèche d'Or" y un VP "Étoile du Nord", ép. II

CIWL, 3-unit pack "Edelweiss Pullman Express", train set 2/2 (DD3, VPC Flèche d'Or + VP Étoile du Nord), ep. II

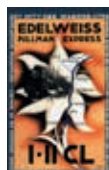

Vetture dotate di illuminazione interna con touch control per attivare e variare l'intensità

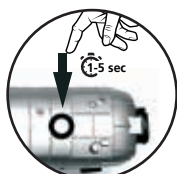



HR4360

IV

873

L

K

←

FS

NEW

FS, set di 3 carrozze "Rapido 904-905", composto da 1 ristorante CIWL 1925T "Pistoiesi", 1 UIC-X '68 di 1a cl. e 1 UIC-X '68 di 2a cl. livrea grigia, fasciar rossa, ep. IV

FS, 3-tlg. Set Reisezugwagen „Rapido 904-905“, bestehend aus 1 x CIWL Speisewagen 1925T, 1 x 1.Kl. Wagen UIC-X '68 und 1 x 2.Kl. Wagen in grauer Farbgebung mit rotem Streifen, Ep. IV

FS, coffret de 3 voitures Rapido 904-905, composé de 1 voiture-restaurant CIWL WR 1925T, 1 voiture de 1ère classe UIC-X '68 et 1 voiture de 2ème classe en livrée grise avec bande rouge, ép. IV

FS, set de 3 coches "Rapido 904-905", compuesto de un coche restaurante CIWL WR 1925T, uno de primera clase UIC-X '68 y uno segunda en decoración gris con franja roja, ép. IV

FS, 3-unit pack of coaches "Rapido 904-905" including 1 CIWL restaurant coach WR 1925T, 1 x 1st class coach UIC-X '68 and 1 x 2nd class coach in grey livery with red stripe, ep. IV



Assi sostitutivi per corrente alternata: HC6102 (10.50 x 24.50 mm)



Dettagli modello

Carrozza ristorante WR 1925T "Pistoiesi" ex CIWL

- Nuovi stampi per cassa, vetri e telaio della ristorante WR 1925T "Pistoiesi", tipologia di carrozza mai prodotta in precedenza da Rivarossi.
- Riproduzione dettagliata delle nuove apparecchiature sottocassa, del tetto, delle testate ricostruite e dei dettagli sulle fiancate.
- Interni coerentemente modificati.
- Versione con testate ricostruite ed intercomunicanti tubolari.
- Carrelli M4p.
- Livrea CIWL con emblema a centro cassa e fascia rossa "alta velocità" indicante l'abilitazione ai 180 km/h.
- Cinematismo di aggancio corto a norma NEM 362.
- Targhe di percorrenza specifiche in fotoincisione fornite in bustina

Carrozze UIC-X

- Carrozze tipo 1968 con carrelli MDfd di 1ª o 2ª classe.
- Livrea grigio ardesia con fascia rossa "alta velocità" indicante l'abilitazione ai 180 km/h.
- Nuovi predellini sulle porte di salita.
- Nuova riproduzione dei freni a disco sui carrelli.
- Numerazioni inedite.
- Cinematismo di aggancio corto a norma NEM 362.
- Targhe di percorrenza specifiche in fotoincisione fornite in bustina.

**HR4361****IV** **FS****NEW****FS, set di 3 carrozze "Alpen-Express", composto da 1 ristorante ex CIWL 1925T "Pistoiesi", 1 UIC-X di 1a cl. rosso fegato e 1 UIC-X di 2a cl. grigio ardesia, ep. IV**

FS, 3-tlg. Set Reisezugwagen „Alpen-Express“, bestehend aus 1 x CIWL Speisewagen 1925T, 1 x 1.Kl. Wagen UIC-X in rot/grauer Farbgebung und 1 x 2.Kl. Wagen UIC-X in grauer Farbgebung, Ep. IV
 FS, coffret de 3 voitures « Alpen-Express », composé de 1 voiture-restaurant CIWL WR 1925T, 1 voiture de 1ère classe UIC-X en livrée rouge/grise et 1 voiture de 2ème classe UIC-X en livrée grise, ép. IV
 FS, set de 3 coches "Alpen-Express", compuesto de 1 coche restaurante CIWL WR 1925T, 1 coche de primera clase UIC-X en decoración roja/gris y 1 coche de segunda clase UIC-X en decoración gris, ép. IV
 FS, 3-unit pack of coaches "Alpen-Express", including 1 restaurant coach CIWL WR 1925T, 1 x 1st class coach UIC-X in red/grey livery and 1 x 2nd class coach UIC-X in grey livery, ep. IV-V



Assi sostitutivi per corrente alternata: HC6102 (10.50 x 24.50 mm)

Espresso 280/281 "Alpen Express"

I primi collegamenti tra Roma Termini ed il nord Europa lungo l'asse del Brennero denominati "Alpen Express" risalgono al 1952, con sezioni dirette per Germania, Danimarca, Belgio o Olanda. Negli anni vi sono stati numerosi cambiamenti di percorso, con composizioni variabili che comprendevano carrozze tedesche, italiane, danesi e in carico alla CIWL. Nel 1981 il treno perse la sezione danese, dal 1984 definitivamente limitato a Monaco ed effettuato con solo materiale FS, per poi essere sostituito nel 1987 dall'Eurocity "Michelangelo" sullo stesso percorso. Su questo treno hanno sempre fatto presenza fissa le carrozze ristorante ex CIWL 1925T "Pistoiesi".

**HR4362****IV** **FS****NEW****FS, set di 3 carrozze "Alpen-Express", composto da 2 carrozze UIC-X di 2a classe in livrea rosso fegato e 1 bagagliaio UIC-X '70 in livrea grigio ardesia, ep. IV**

FS, 3-tlg. Set Reisezugwagen „Alpen-Express“, bestehend aus 2 x 2.Kl. Wagen UIC-X in rot/grauer Farbgebung und 1 x Gepäckwagen UIC-X '70, Ep. IV
 FS, coffret de 3 voitures « Alpen-Express », composé de 2 voitures de 2ème classe UIC-X en livrée rouge/grise et 1 fourgon UIC-X '70 en livrée grise, ép. IV
 FS, set de 3 coches "Alpen-Express", compuesto de 2 coches de segunda clase UIC-X en decoración roja/gris y 1 furgón UIC-X '70 en decoración gris, ép. IV
 FS, 3-unit pack of coaches "Alpen-Express", including 2 x 2nd coaches UIC-X in red/grey livery and 1 x luggage van UIC-X '70 in grey livery, ep. IV



Assi sostitutivi per corrente alternata: HC6102 (10.50 x 24.50 mm)

Carrozze UIC-X FS

- Carrozze di 1ª o 2ª classe dei tipi 1968, 1975 o 1982 e bagagliaio Tipo 1970 senza carenature in livrea rosso fegato o grigio ardesia in base alla versione riprodotta, in numerazioni e varianti inedite
- Nuovi predellini sulle porte di salita
- Nuova riproduzione dei freni a disco sui carrelli
- Targhe di percorrenza specifiche in fotoincisione fornite in bustina





HR4374



FS/DB/NS

NEW

“Italien-Holland Express”, set di 4 carrozze, 1 letti MU NS livrea TEN, 1 cuccetta DB Bcm 243 blu/beige, 1 UIC-X 2° cl. FS rosso fegato e 1 cuccetta UIC-X '68 FS rosso fegato, ep. V

„Italien-Holland-Express“, 4-tlg. Set Reisezugwagen, bestehend aus 1 x NS WLABm MU, in TEN-Farbgebung, 1 x DB Bcm 243, in blau/beiger Farbgebung, 1 x FS 2.Kl. UIC-X, in rot/grauer Farbgebung und 1 x FS Liegewagen UIC-X '68, in rot/grauer Farbgebung, Ep. V

« Italien-Holland-Express », composé de 1 voiture NS WLABm MU en livrée TEN, 1 voiture DB Bcm 243 en livrée bleue/beige, 1 voiture FS de 2ème classe UIC-X en livrée rouge/grise et 1 voiture-couchette FS en livrée rouge/grise UIC-X '68, ép. V

“Italien-Holland Express”, set de 4 coches, compuesto de un coche WLABm MU de la NS en decoración “TEN”, un Bcm 243 de la DB en azul/beige, un 2º clase UIC-X de la FS en rojo/gris y un literas UIC-X '68 de la FS en rojo/gris, ép. V

“Italien-Holland-Express”, 4-unit pack of coaches, including 1 x NS coach WLABm MU in TEN livery, 1 x DB coach Bcm 243 in blue/beige livery, 1 x FS 2nd class coach UIC-X in red/grey livery and 1 x FS couchette coach UIC-X '68 in red/grey livery, ep. V

Assi sostitutivi per corrente alternata: HC6102 (10.50 x 24.50 mm)



Espresso 200 “Italien-Holland Express” / 201 “Holland-Italien Express”

Nell'ambito della grande rete di treni espressi internazionali circolanti in Europa sin dagli anni '50, la relazione denominata “Italien-Holland Express” oppure “Holland-Italien Express” (se in direzione sud-nord oppure nord-sud) che collegava Roma con Amsterdam ha sempre giocato un ruolo di primo piano, dovendo attraversare, oltre ad Italia ed Olanda, anche la Svizzera via Chiasso/Gottardo e la Germania lungo la valle del Reno, con fermate intermedie nelle città più importanti incontrate nel percorso come Milano, Basilea, Bonn, Colonia e Utrecht solo per citarne alcune. Come sempre in questi casi, la composizione era notevolmente variabile lungo il percorso, data la presenza di sezioni non solo per Amsterdam ma anche limitate in Svizzera o Germania (es. per Basilea, Dortmund, Francoforte o Emmerich in base al periodo) o con origine da Svizzera o Germania; in alcuni periodi dell'anno (estate o festività) il treno aveva origine in Italia da località turistiche come Ventimiglia (per la Riviera Ligure) o Rimini (per la Riviera Romagnola), mentre ad inizio anni '90 venne limitato a Milano anziché Roma.

Data la lunga percorrenza, oltre a normali carrozze diurne e bagagliai, questo treno ha sempre avuto in composizione anche carrozze letti e cuccette, generalmente in carico alle FS, DB e NS, ma occasionalmente si sono viste in composizione anche carrozze letti SNCF o SBB, in particolare nel periodo del pool TEN quando potevano capitare nella rotazione dei turni anche su questa tratta.



Dettagli modello

Carrozze cuccette Bcm243 DB / UIC-X 1968 cuccette FS

Nuovi stampi per cassa, vetri, interni, sottocassa e dettagli separati. Differenze tra versioni DB, FS e tra sottoserie diverse correttamente riprodotte. Riproduzione dettagliata delle nuove apparecchiature sottocassa, del tetto, delle testate, differenziate in base al tipo di carrozza ed alla sottoserie. Interni interamente riprodotti, con cuccette aperte e scalette in fotoincisione. Nuovi predellini sulle porte di salita, differenziati in base alla sottoserie (fissi o ribaltabili). Carrelli MD36, MDf o 24au in base alla serie della carrozza.

Carrozze UIC-X FS

Carrozze UIC-X di 2° classe FS dei tipi 1975, 1979 o 1982 in livrea rosso fegato o grigio ardesia in base alla versione riprodotta, in numerazioni e varianti inedite. Nuovi predellini sulle porte di salita. Nuova riproduzione dei freni a disco sui carrelli.

Carrozze letti MU

Carrozze tipo MU 1973 con freni a disco, in livrea TEN con tetto blu, in carico alle Ferrovie Olandesi (NS), versione mai prodotta da Rivarossi. Nuova riproduzione dei freni a disco sui carrelli.

Per tutte le carrozze

Cinematismo di aggancio corto a norma NEM 362. Respingenti e tubolari degli intercomunicanti molleggiati, Targhe di percorrenza specifiche in fotoincisione fornite in bustina, secondo l'Orario Invernale 1993-1994.



HR4375



FS/DB

NEW

“Italien-Holland Express”, set di 4 carrozze, 1 cuccetta DB Bcm 243 blu/beige, 1 UIC-X 2a cl. FS rosso fegato, 1 UIC-X 2° cl. FS grigio ardesia e 1 cuccetta UIC-X '68 FS rosso fegato, ep. V

„Italien-Holland-Express“, 4-tlg. Set Reisezugwagen, bestehend aus 1 x DB Bcm 243, in blau/beiger Farbgebung, 1 x FS 2.Kl. UIC-X, in rot/grauer Farbgebung, 1 x FS 2.Kl. UIC-X, in grauer Farbgebung und 1 x FS-Liegewagen UIC-X '68, in rot/grauer Farbgebung, Ep. V

«Italien-Holland-Express», composé de 1 voiture DB Bcm 243 en livrée bleue/beige, 1 voiture FS de 2ème classe UIC-X en livrée rouge/grise, 1 voiture FS de 2ème classe UIC-X en livrée grise et 1 voiture-couchette FS en livrée rouge/grise UIC-X '68, ép. V

“Italien-Holland Express”, set de 4 coches, compuesto de un coche Bcm 243 de la DB en azul/beige, un 2º clase UIC-X de la FS en rojo/gris, un 2º clase UIC-X de la FS en gris y un literas UIC-X '68 de la FS en rojo/gris, ép. V

“Italien-Holland-Express”, 4-unit pack of coaches, including 1 x DB coach Bcm 243 in blue/beige livery, 1 x FS 2nd class coach UIC-X in red/grey livery, 1 x FS 2nd class coach UIC-X in grey livery and 1 x FS couchette coach UIC-X '68 in red/grey livery, ep. V

Assi sostitutivi per corrente alternata: HC6102 (10.50 x 24.50 mm)



Photo: Giorgio Stagni

**HR4376****FS****NEW****FS, set di 2 carrozze cuccette UIC-X Tipo 1968, livrea XMPR, ep. V**

FS, 2-tlg. Set Liegewagen UIC-X '68, in XMPR-Farbgebung, Ep. V

FS, coffret de 2 voitures couchettes UIC-X Type 1968, livrée XMPR, ép. V

FS, set de dos coches literas UIC-X '68, decoración "XMPR", ép. V

FS, 2-unit pack of couchette coaches UIC-X '68, XMPR livery, ep. V



Assi sostitutivi per corrente alternata: HC6102 (10.50 x 24.50 mm)

**Carrozze UIC-X 1968 a cuccette delle FS**

Le cuccette Tipo 1968 rappresentano la prima serie di carrozze di questo tipo costruite sulla piattaforma UIC-X per le FS; derivate direttamente dalle UIC-X 1968 diurne costruite in contemporanea, ne mantengono la stessa struttura della cassa ma diversa organizzazione degli interni, presentando 10 scompartimenti per i viaggiatori più 1 per l'accudiente, con 4 lavabi oltre alle 2 ritirate. La prima sottoserie di 92 carrozze venne consegnata tra il 1968 ed il 1970, caratterizzata dai carrelli 24au, aria soffiata di tipo

Westclimat e riscaldamento a vapore, subito seguita nel 1970-71 da un'altra sottoserie di 160 carrozze identiche alla prima ma senza riscaldamento a vapore, per finire la fornitura nel 1973 con un'ultima sottoserie di 30 unità dotate di carrelli MDfd con freni a disco, che garantivano migliori qualità di marcia, ed impianto ad aria soffiata Friedmann, analogamente alle carrozze diurne della stessa serie. Nel corso degli anni, come tutte le carrozze UIC-X, hanno subito diverse modifiche come l'installazione di

nuove porte in lega, gradini di salita ribaltabili ed altri aggiornamenti tecnici; anche la livrea è cambiata nel tempo, passando dall'originale grigio ardesia al rosso fegato/grigio beige negli anni '80 ed all'XMPR negli anni '90, quest'ultima mantenuta fino a fine carriera avvenuta attorno al 2010 per questa serie di carrozze.

**HR4349****DB****NEW****DB, set di 3 carrozze, treno notturno "Luna", composto da 1 carrozza Club WGMh 854 in livrea rosso/beige e 2 carrozze Bcm 246 in livrea blu oceano/beige, ep. IV**

DB, 3-tlg. Set Nachtschnellzug „Luna“, bestehend aus 1 x Bar-Gesellschaftswagen WGMh 854, in rot/beiger Farbgebung und 2 x Bcm 246, in ozeanblauer Farbgebung, Ep. IV

DB, coffret de 3 voitures, train de nuit « Luna », composé de 1 voiture Club WGMh 854 en livrée rouge/beige et 2 voitures Bcm 246 en livrée bleu océan, ép. IV

DB, set de 3 coches, tren nocturno "Luna", compuesto de 1 coche Club WGMh 854 en decoración rojo/beige y 2 coches bcm 246 en decoración océano azul, ép. IV

DB, 3-unit pack, night train "Luna", including 1 Club coach WGMh 854 in red/beige livery and 2 coaches Bcm 246 in ocean blue livery, ep. IV



Assi sostitutivi per corrente alternata: HC6102 (10.50 x 24.50 mm)





HR4377



DB

NEW

DB, set di 2 carrozze cuccette Bcm²⁴³, livrea verde, ep. III

DB, 2-tlg. Set Liegewagen Bcm²⁴³, in grüner Farbgebung, Ep. III

DB, coffret de 2 voitures couchettes Bcm²⁴³, livrée verte, ép. III

DB, set de dos coches literas Bcm²⁴³, decoración verde, ép. III

DB, 2-unit pack of couchette coaches Bcm²⁴³, green livery, ep. III



Assi sostitutivi per corrente alternata: HC6102 (10.50 x 24.50 mm)



HR4378



Nightjet

NEW

NightJet, set di 2 carrozze cuccette Bvcmz^{248.5}, livrea blu, ep. VI

NightJet, 2-tlg. Set Liegewagen Bvcmz^{248.5}, in blauer Farbgebung, Ep. VI

NightJet, coffret de 2 voitures couchettes Bvcmz^{248.5}, livrée bleue, ép. III

NightJet, set de dos coches literas Bvcmz^{248.5}, decoración azul, ép. VI

NightJet, 2-unit pack of couchette coaches Bvcmz^{248.5}, blue livery, ep. VI



Assi sostitutivi per corrente alternata: HC6102 (10.50 x 24.50 mm)



**HR4365****III** **L****K****FS****NEW****FS, set di 3 carrozze Tipo 1946, composto da 1 bagagliaio Dz 83000, 1 carrozza di 1a classe Az 13010 e 1 carrozza di 2a classe Bz 33010, livrea castano, ep. III**

FS, 3-tlg. Set Reisezugwagen, in brauner Castano-Farbgebung, bestehend aus 1 x Gepäckwagen Dz 83000, 1 x 1.Kl. Wagen Az 13010 - Typ 1946 und 1 x 2.Kl. Wagen Bz33010 - Typ 1946, Ep. III

FS, coffret de 3 voitures, livrée castano, composé de 1 fourgon Dz 83000, 1 voiture de 1ère classe Az 13010 Type 1946 et 1 voiture de 2ème classe Bz33010 Type 1946, ép. III

FS, set de 3 coches, compuesto de un furgón Dz 83000, un coche de primera clase Az 13010 Tipo 1946 y uno de segunda clase Bz 33010 Tipo 1946, decoración "castaño", ép. III

FS, 3-unit pack of coaches, castano livery, including 1 x luggage van Dz 83000, 1 x 1st class coach Az 13010 Type 1946 and 1 x 2nd class coach Bz33010 Type 1946, ep. III

Assi sostitutivi per corrente alternata: HC6102 (10.50 x 24.50 mm)

*Fotomontage / Fotomontaje / Photomontage / Fotomontaggio***HR4366****IV** **L****K****FS****NEW****FS, set di 2 carrozze Tipo 1946, composto da 1 bagagliaio per trasporto biciclette Dz 83000 e 1 carrozza di 2a classe Bz 33010, livrea grigia, ep. IV**

FS, 2-tlg. Set Reisezugwagen, in grauer Farbgebung, bestehend aus 1 x Gepäckwagen Dz 83000 für Fahrradtransport und 1 x 2.Kl. Wagen Bz33010 - Typ 1946, Ep. IV

FS, coffret de 2 voitures, livrée grise, composé de 1 fourgon Dz 83000 pour le transport de vélos et 1 voiture de 2ème classe Bz33010 Type 1946, ép. IV

FS, set de 2 coches, compuesto de un furgón para el transporte de bicicletas Dz 83000 y un coche de segunda clase Bz 33010 Tipo 1946, decoración gris, ép. IV

FS, 2-unit pack of coaches, grey livery, including 1 luggage van for bicycles transport Dz 83000 and 1 2nd class coach Bz 33010 Type 1946, ep. IV

Assi sostitutivi per corrente alternata: HC6102 (10.50 x 24.50 mm)

*Fotomontage / Fotomontaje / Photomontage / Fotomontaggio*

**HR4367****III****523****L****K****FS****NEW****FS, set di 2 carrozze Tipo 1946, composto da 2 carrozze di 2a classe Bz 33010, una con comparto ristoro, livrea castano/Isabella, ep. III**

FS, 2-tlg. Set 2.Klasse Reisezugwagen Bz 33010 - Typ 1946, in brauner Castano/Isabella-Farbgebung, einer davon mit Buffett-Abteil, Ep. III

FS, coffret de 2 voitures, livrée castano/Isabella, composé de 1 voiture de 2ème classe avec compartiment buffet Bz 33010 Type 1946 et 1 voiture de 2ème classe Bz 33010 Type 1946, ép. III

FS, set de 2 coches, compuesto de un coche de segunda clase Bz 33010 Tipo 1946 con cabina "ristoro" y uno de segunda clase Bz 33010, decoración "castaño/Isabella", ép. III

FS, 2-unit pack of coaches, Castano/Isabella livery, including 1 x 2nd class coach Bz 33010 Type 1946 with "ristoro" compartment and 1 x 2nd class coach Bz 33010, ep. III

Assi sostitutivi per corrente alternata: HC6102 (10.50 x 24.50 mm)

*Fotomontage / Fotomontaje / Photomontage / Fotomontaggio***HR4368****III-IV****523****L****K****FS****NEW****FS, set di 2 carrozze Tipo 1946, composto da 2 carrozze di 2a classe Bz 33010, una con comparto ristoro, livrea grigio ardesia, marcatura FS, ep. III-IV**

FS, 2-tlg. Set, bestehend aus einem Wagen 2. Kl. Bz 33010 der Bauart 1946 mit „Ristoro“-Abteil und einem Wagen 2. Kl. Bz 33010 in „grigio ardesia“ mit FS-Anschriften, Ep. III-V

FS, coffret de 2 voitures, composé d'une voiture de 2e cl. Bz 33010 du type 1946 avec compartiment « Ristoro » et d'une voiture de 2e cl. Bz 33010 en « grigio ardesia » avec inscriptions FS, ép. III-IV

FS, set de 2 coches, compuesto de un coche de segunda clase Bz 33010 Tipo 1946 con cabina "ristoro" y uno de segunda clase Bz 33010, decoración "grigio ardesia" con inscripciones FS, ép. III-IV

FS, 2-unit pack Bz 33010 Type 1946 2nd class, one with "ristoro" compartment, FS markings, grey livery, ep. III-IV

Assi sostitutivi per corrente alternata: HC6102 (10.50 x 24.50 mm)

*Fotomontage / Fotomontaje / Photomontage / Fotomontaggio*

171



HR4399

IV FS

NEW

FS, carrozza letti MU '73 in livrea TEN, tetto color alluminio, logo FS a "televisore" + logo "Raitour", ep. IV

FS, Schlafwagen der Bauart MU '73 in TEN-Lackierung, Aluminiumdach, abgerundetes FS-Logo + „Raitour“-Logo, Ep. IV

FS, voiture-lits MU '73 en livrée TEN, toit en couleur aluminium, logo FS arrondi + logo « Raitour », ép. IV

FS, coche cama MU '73 en livrea TEN, techo en color aluminio, logotipo FS redondeado + logotipo "Raitour", ep. IV

FS, sleeping coach MU '73 in TEN livery, aluminium roof, rounded FS logo + "Raitour" logo, ep. IV

Assi sostitutivi per corrente alternata: HC6102 (10.50 x 24.50 mm)

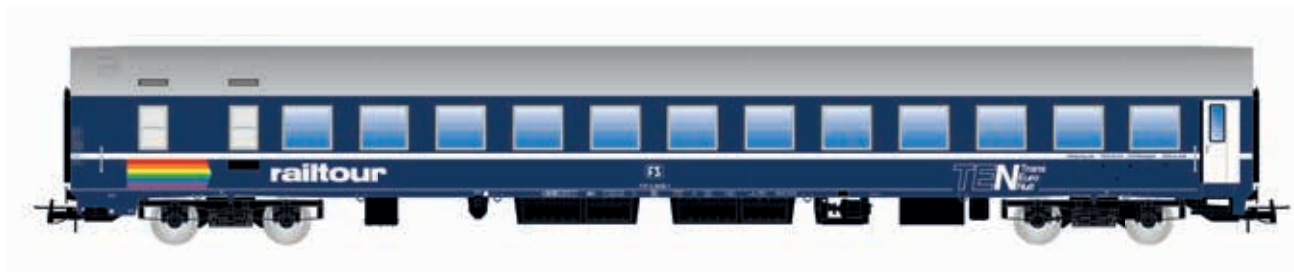

HR4400

IV FS

NEW

FS, carrozza letti tipo MU '73 in livrea CIWL con emblema, ep. IV

FS, Schlafwagen der Bauart MU '73 in CIWL-Farbgebung mit Emblem, Ep. IV

FS, voiture-lits type MU '73 en livrée CIWL avec emblème, ép. IV

FS, coche cama tipo MU '73, decoración CIWL con escudo, ép. IV

FS, sleeping coach type MU '73 in CIWL livery with emblem, ep. IV

Assi sostitutivi per corrente alternata: HC6102 (10.50 x 24.50 mm)





HR4389



DB

NEW

DB, set di 5 carrozze passeggeri "Blauer Enzian", livrea blu, ep. III

DB, 5-tlg. Zugset „Blauer Enzian“ in blauer Farbgebung, Ep. III

DB, coffret de 5 voitures voyageurs « Blauer Enzian », livrée bleue, ép. III

DB, set de 5 coches del tren "Blauer Enzian", decoración azul, ép. III

DB, 5-unit pack luxury passenger train "Blauer Enzian", blue livery, ep. III



Photo: Collezione Rivarossi

Blauer Enzian-Zug

Ab Sommerfahrplan 1953 wurde der Zug durch die eingesetzten Wagen aus den Fernschnellzügen herausgehoben. Die Garnitur des früheren Henschel-Wegmann-Zuges, die einen Aussichts-Schlusswagen nach US-Vorbild führte (Kanzelwagen), wurde speziell für diesen Einsatz aufgearbeitet. Wegen Problemen beim Umbau der Zuggarnitur, die ursprünglich aus Wagen mit Abteilen zweiter und dritter Klasse bestand, entschied die DB, den Zug generell auf die (damalige) zweite Wagenklasse umzurüsten.

Der Name „Blauer Enzian“, den die Verbindung seit Sommerfahrplan 1952 trug, war das Ergebnis eines Preisausschreibens, das die DB unter ihren Fahrgästen 1951 veranstaltete. Insgesamt wurden so für neun F-Zug-Paare Namen vergeben. Für den F 55/56 kristallisierte sich der Name „Blauer Enzian“ als Gewinner heraus. Enzian ist wie das Edelweiß – namensgebend für den Edelweiss-Express – eine Alpenblume und Heilpflanze. In Europa wachsen etwa 35 Enzian-Arten vorwiegend in den Alpen. Möglicherweise wegen ihrer im Pflanzenreich seltenen reinblauen und leuchtenden Blütenfarbe, wurden und werden sie als Symbol für die Treue betrachtet und werden so in Gedichten und Liedern erwähnt. Streckenführung und Farbgebung des Zugs können die Assoziation erklären.



HR4346

IV

1224

L

K

DB

DB, 4-tlg. Set Reisezugwagen „TEE Rheingold”, in beige/roter Lackierung, bestehend aus 2 x 1. Kl. Wagen Avmz, 1 x 1 Kl. Wagen Apmz und 1 x Speisewagen WRmh¹³², Ep. IV

DB, set di 4 carrozze “TEE Rheingold”, livrea beige/rossa, composto da 2 carrozze di 1a classe Avmz, 1 carrozza di 1a classe Apmz e 1 carrozza ristorante WRmh¹³², ep. IV

DB, coffret de 4 voitures « TEE Rheingold », livrée beige/rouge, composé de 2 voitures de 1ère classe Avmz, 1 voiture de 1ère classe Apmz et 1 voiture restaurant WRmh¹³², ép. IV

DB, set de 4 coches «TEE Rheingold», decoración beige/roja, compuesto de 2 coches de primera clase Avmz, 1 coche de primera clase Apmz y 1 coche restaurante WRmh¹³², ép. IV

DB, 4-unit set of coaches “TEE Rheingold”, beige/red livery, including 2 1st class coaches Avmz, 1 1st class coach Apmz and 1 restaurant coach WRmh¹³², period IV



Assi sostitutivi per corrente alternata: HC6102 (10.50 x 24.50 mm)



**HR4347****IV****1212****L****K****DB****DB, 4-tlg. Set Reisezugwagen „TEE Rheingold“, in beige/roter Lackierung, bestehend aus 2 x 1. Kl. Wagen Avmz¹¹¹, 1 x 1. Kl. Wagen Apmz¹²¹ und 1 x Clubwagen WGmh⁸⁰⁴, Ep. IV**DB, set di 4 carrozze «TEE Rheingold», livrea beige/rossa, composto da 2 carrozze di 1a classe Avmz¹¹¹, 1 carrozza di 1a classe Apmz¹²¹ e 1 carrozza Club WGmh⁸⁰⁴, ep. IVDB, coffret de 4 voitures «TEE Rheingold», livrée beige/rouge, composé de 2 voitures de 1ère classe Avmz¹¹¹, 1 de 1ère classe Apmz¹²¹ et 1 voiture Club WGmh⁸⁰⁴, ép. IVDB, set de 4 coches «TEE Rheingold», decoración beige/roja, compuesto de 2 coches de primera clase Avmz¹¹¹, 1 coche de primera clase Apmz¹²¹ y 1 coche Club WGmh⁸⁰⁴, ép. IVDB, 4-unit set of coaches «TEE Rheingold», beige/red livery, including 2 1st class coaches Avmz¹¹¹, 1 1st class coach Apmz¹²¹ and 1 Club coach WGmh⁸⁰⁴, period IV

Asse sostitutivi per corrente alternata: HC6102 (10.50 x 24.50 mm)

Reisezugwagen „TEE Rheingold“

Mit Einführung des zweiklassigen „IC 79“-Systems, wurden nach und nach immer mehr TEE-Züge in dieses integriert. Eine der wenigen Ausnahmen war der TEE „Rheingold“. Die Deutsche Bundesbahn entschloss sich Anfang der achtziger Jahre diesen Zug wieder zu einem Luxuszug aufzuwerten.

Dazu wurden mehrere InterCity-Wagen sowie Speisewagen umgebaut und modernisiert. Zu erkennen waren diese Wagen an ihrer rot-beigen Lackierung, die nun unterhalb der Fenster einen orangen Zierstreifen besaß. Ebenso war der Schriftzug „Restaurant“ an den Speisewagen in Orange ausgeführt.

Der Zug verkehrte auf wechselnden Laufwegen von Amsterdam nach Basel mit einem Flügelzug nach München bzw. Salzburg. Der 30. Mai 1987 war der letzte Verkehrstag des TEE „Rheingold“. Mit ihm endete die Ära der Trans-Europ-Express-Züge in Deutschland.



**HR4397****IV****606****L****K****DB****NEW****DB, set di 2 carrozze di 1a classe del tipo Avmz¹¹¹ in colorazione Rheingold-'83, ep. IV (per completare i set HR4346 e HR4347)**DB, 2-tlg. Set 1.-Kl.-Wagen der Bauart Avmz¹¹¹ in Rheingold-'83-Farbgebung, Ep. IV (zur Komplettierung der Sets HR4346 und HR4347)DB, coffret de 2 voitures de 1ère classe du type Avmz¹¹¹ en livrée Rheingold '83, ép. IV (pour compléter les coffrets HR4346 et HR4347)DB, set de dos coches tipo Avmz¹¹¹, decoración "Rheingold 1983", ép. IV (para completar los sets HR4346 y HR4347)DB, 2-unit pack Avmz¹¹¹ 1st cl. coaches in Rheingold 1983 livery, ep. IV (they complete the packs HR4346 and HR4347)

Assi sostitutivi per corrente alternata: HC6102 (10.50 x 24.50 mm)

*Fotomontage / Fotomontaje / Photomontage / Fotomontaggio***HR4348****IV****303****L****K****DB****DB, carrozza Club WGmh⁸⁵⁴, livrea "InterRegio", ep. IV**DB, Bar-Gesellschaftswagen WGmh⁸⁵⁴, in „InterRegio“-Farbgebung, Ep. IVDB, voiture Club WGmh⁸⁵⁴, livrée « InterRegio », ép. IVDB, coche Club WGmh⁸⁵⁴, decoración «InterRegio», ép. IVDB, Club coach WGmh⁸⁵⁴, "InterRegio" Livery, ep. IV

Assi sostitutivi per corrente alternata: HC6102 (10.50 x 24.50 mm)



**HR4395****VI****303****E****K****DB****NEW****DB, carrozza bar WGmh⁸⁰⁴ per treni storici in livrea originale, ep. VI**DB, Barwagen WGmh⁸⁰⁴ in Ursprungsfarbgebung für historische Züge, Ep. VIDB, voiture-bar WGmh⁸⁰⁴ pour trains historiques en livrée d'origine, ép. VIDB, coche bar tipo WGmh⁸⁰⁴, para trenes históricos, ép. VIDB, bar coach WGmh⁸⁰⁴ for historic trains in original livery, ep. VI

Assi sostitutivi per corrente alternata: HC6102 (10.50 x 24.50 mm)

*Fotomontage / Fotomontaje / Photomontage / Fotomontaggio***HR4350****VI****619****E****K****EURO-EXPRESS****Euro-Express, set di 2 carrozze, composto da 1 carrozza "Partywagen" WGmh 804/854 e 1 carrozza ristorante WRmh 132, ep. VI**

Euro-Express, 2-tlg. Set Reisezugwagen, bestehend aus 1 x Partywagen WGmh 804/854 und 1 x Speisewagen WRmh 132, Ep. VI

Euro-Express, coffret de 2 voitures, composé de 1 voiture « Partywagen » WGmh 804/854 et 1 voiture restaurant WRmh 132, ép. VI

Euro-Express, set de 2 coches, compuesto de 1 coche "Partywagen" WGmh 804/854 y 1 coche restaurante WRmh 132, ép. VI

Euro-Express, 2-unit set of coaches, including 1 "Partywagen" coach WGmh 804/854 and 1 restaurant coach WRmh 132, ep. VI



Assi sostitutivi per corrente alternata: HC6102 (10.50 x 24.50 mm)



**HR4373****VI****922****L****K****DB****DB, set di 3 carrozze "TEE Bavaria", livrea rossa/beige, composto da 1 carrozza Apmz, 1 carrozza Avmz e 1 carrozza ARDm, ep. IV**

DB, 3-tlg. Set Reisezugwagen „TEE Bavaria“ in rot/beiger Farbgebung, bestehend aus 1 x Apmz, 1 x Avmz, 1 x ARDm, Ep. IV

DB, coffret de 3 voitures « TEE Bavaria », livrée rouge/beige, composé de 1 voiture Apmz, 1 voiture Avmz et 1 voiture ARDm, ép. IV

DB, set de 3 coches «TEE Bavaria», decoración roja/beige, compuesto de 1 coche Apmz, 1 coche Avmz y 1 coche ARDm, ép. IV

DB,3-unit set of coaches "TEE Bavaria", red/beige livery, including 1 coach Apmz, 1 coach Avmz and 1 coach ARDm, ep. IV

Assi sostitutivi per corrente alternata: HC6102 (10.50 x 24.50 mm)

TEE Bavaria

Ein sehr bekannter, internationaler Fernzug, war der „Bavaria“. Von 1969 bis 1977 war er Bestandteil des Trans-Europäischen-Eisenbahn-Netzes, kurz TEE genannt. Er verkehrte in der Relation München – Zürich und befuhr dabei die landschaftlich schöne Allgäubahn bis Lindau. Die zunächst eingesetzten 4-teiligen Dieseltriebzüge des Typs RAm wurden nach einem schweren Unfall 1971 dort nicht mehr eingesetzt.

Als Nachfolge wurden die deutschen TEE-Wagen des Typs Avmz 111 (Abteilwagen) und Apmz 121 (Großraumwagen) sowie als Besonderheit der extra in TEE-Farben lackierte SBB-Speisewagen WRm eingesetzt. Mit den goldbedampften Einstiegstüren, den Aufschriften „TEE“ mit Ring-Umrandung sowie „Restaurant“ war dieser schon von weitem von allen anderen TEE-Wagen leicht zu unterscheiden. Der Zug verkehrte drei- bzw. vierteilig, je nach Auslastung.

Als Zuglokomotiven kam die neue Baureihe 210 zwischen München und Lindau zum Einsatz, ersatzweise auch die Baureihe 218, zunächst im ursprünglichen purpurrot, ab Mitte der 1970-er Jahre auch in den neuen Farben ozeanblau/beige.

Ab 1977 wurde der TEE 66/67 „Bavaria“ zum D-Zug herabgestuft und Ende 2002 verlor die Zugverbindung München – Zürich endgültig den Namen „Bavaria“.



**HR4392****DR****NEW****DR, set di 4 carrozze a due piani con carrozza pilota, livrea verde con con tetto grigio, ep. III**

DR, 4-tlg. Doppelstockeinheit mit Steuerabteil, in grüner Farbgebung mit grauem Dach, Ep. III

DR, coffret de 4 voitures à deux niveaux avec voiture-pilote, livrée verte toit gris, ép. III

DR, set de 4 coches de doble piso con coche piloto, con techo verde/gris, ép. III

DR, 4-unit double-decker coach with cab-control unit, with green/grey roof, ep. III

*Fotomontage / Fotomontaje / Photomontage / Fotomontaggio***DR Doppelstockwagen**

In der DDR entwickelte 1952 der VEB Waggonbau Görlitz (ehemals Waggon- und Maschinenbau AG (WUMAG)) für die Deutsche Reichsbahn auf den LBE-Fahrzeugen aufbauende zwei- und vierteilige Doppelstockzüge. Von den 39,9 Meter langen und 76 Tonnen schweren Zweiteilern DB7, später DBz, lieferte Görlitz 1955 nur zwölf Einheiten aus. Sie verfügten über 228 Sitz- und 210 Stehplätze. Die vierteiligen 73,4 Meter langen DB13, später DBv, waren mit 152 Exemplaren im Betriebsmittelpark der DR vertreten. Sie boten insgesamt 906 Fahrgästen Platz. Zwei- und vierteilige Einheiten waren fast identisch, bei den zweiteiligen fehlten nur die Mittelwagen.

Wie bei den LBE-Wagen lagen je zwei einzelne Wagen auf einem Jakobsdrehgestell auf, die Türen befanden sich über den Drehgestellen. Aus Achslastgründen insbesondere beim Einsatz auf Nebenbahnen waren die Jakobsdrehgestelle im Gegensatz zu denen der LBE-Wagen dreiachsig. Der Wagenkasten war in selbsttragender Ganzstahl-Leichtbauweise ausgeführt.

Lauftechnisch waren die Fahrzeuge für 120 km/h ausgelegt, bremstechnisch betrug die zulässige Geschwindigkeit anfangs 100 km/h. Die Einheiten wurden mit Hildebrand-Knorr-Personenzugbremse geliefert, wegen des hohen Anteils der Reisenden an der Gesamtmasse von Anfang an mit automatischer Lastabbremmung (Hik-GP-A).

Die Wagen hatten beidseitig zwei Doppeltüren mit einer lichten Breite von 1,5 Metern im einstöckigen Bereich über den Drehgestellen. In den Endwagen befanden sich im einstöckigen Bereich auch eine Toilette und ein Dienstabteil. Innentüren zwischen Einstiegs- und Fahrgasträumen wurden bei den zwei- und vierteiligen Einheiten nicht vorgesehen. Die Fenster im Oberstock waren geteilt, der untere, senkrechte Teil konnte mit einer Kurbel geöffnet werden. Bei den übrigen Fenstern war das obere Drittel nach innen klappbar. Die Sitzplatzanordnung betrug 2+3 bei halbhohen Rückenlehnen, bei der Abschaffung der dritten Wagenklasse wurden die Fahrzeuge in die zweite Klasse umgestuft.

Hornby archive



179



HR4393

IV

845

L

K

DR

DR

NEW

DR, set di 4 carrozze a due piani senza carrozza pilota, livrea verde con con tetto grigio, ep. IV

DR, 4-tlg. Doppelstockeinheit ohne Steuerabteil, in grüner Farbgebung mit grauem Dach, Ep. IV

DR, coffret de 4 voitures à deux niveaux sans voiture-pilote, livrée verte toit gris, ép. IV

DR, set de 4 coches de doble piso sin coche piloto, con techo verde/gris, ép. IV

DR, 4-unit double-decker coach without cab-control unit, with green/grey roof, ep. IV



Fotomontage / Fotomontaje / Photomontage / Fotomontaggio



HR4394

IV

845
C 9

L

K

DR

DR

NEW

DR, serie di 4 carrozze a due piani con scomparto di comando e pannelli frontali di destra in livrea verde/grigia, grande logo "DR", scritte IV

DR, 4-tlg. Doppelstockeinheit mit Steuerabteil und gerade Frontseiten in grün/grauer Farbgebung, großes „DR“-Logo, Ep. IV

DR, coffret de 4 voitures à deux niveaux avec compartiment de commande et faces avant droites en livrée verte/grise, grand logo « DR », ép. IV

DR, set de 4 coches de dos pisos con coche piloto y testeros rectos en livrea verde/gris, gran logotipo "DR", ep. IV

DR, 4-unit double-decker coach with driver's cab, straight fronts, green and grey livery "DR", ep. IV



Fotomontage / Fotomontaje / Photomontage / Fotomontaggio



HR4380 **IV** **606** **K** **DR**

DR, set di 2 carri DDm⁹¹⁶ per trasporto auto al seguito, livrea verde, ep. IV

DR, 2-tlg. Set Autotransportwagen DDm⁹¹⁶, in grüner Farbgebung, Ep. IV
DR, coffret de 2 unités, fourgon porte-autos DDm⁹¹⁶, livrée verte, ép. IV
DR, set de 2 unidades, vagón plataforma DDm⁹¹⁶ para coches, decoración verde, ép. IV
DR, 2-unit pack of car transporters DDm⁹¹⁶, green livery, ep. IV



Fotomontage / Fotomontaje / Photomontage / Fotomontaggio



HR4381 **V** **303** **K** **DB AG**

DB AG, carro DDm⁹¹⁶ per trasporto auto al seguito, livrea verde, ep. V

DB AG, Autotransportwagen DDm⁹¹⁶, in grüner Farbgebung, Ep. V
DB AG, fourgon porte-autos DDm⁹¹⁶, livrée verte, ép. V
DB AG, vagón plataforma portacoaches DDm⁹¹⁶ para coches, decoración verde, ép. V
DB AG, car transporter DDm⁹¹⁶, green livery, ep. V



Die neuen Autotransportwagen der Bauart DDm916

- Vollständige Neukonstruktion
- Modell mit Chassis aus Zinkdruckguss für einigen tiefliegenden Schwerpunkt
- Unterschiedliche Detaillierung je nach Ausführung
- Viele separate angesetzte Details, teilweise aus rostfreiem Edelstahl geätzt
- Kurzkupplungskulissen nach NEM 352
- Kupplungsaufnahmen nach NEM 362
- Fein profilierte und dunkel vernickelte Radsätze



Fotomontage / Fotomontaje / Photomontage / Fotomontaggio

**HR4382****DB Autozug****DB AG, carro DDm⁹¹⁶ per trasporto auto al seguito, livrea rossa, "DB Autozug", ep. V**DB AG, Autotransportwagen DDm⁹¹⁶, in roter Farbgebung, „DB Autozug“, Ep. VDB AG, fourgon porte-autos DDm⁹¹⁶, livrée rouge, « DB Autozug », ép. VDB AG, vagón plataforma portacoaches DDm⁹¹⁶ para coches, decoración roja, "DB Autozug", ép. VDB AG, car transporter DDm⁹¹⁶, red livery, "DB Autozug", ep. V*Fotomontage / Fotomontaje / Photomontage / Fotomontaggio***HR4383****ZXBENET****ZXBENET, carro DDm⁹¹⁶ per trasporto auto al seguito, con griglie protettive, livrea blu, ep. VI**ZXBENET, Autotransportwagen DDm⁹¹⁶, mit Schutzgittern in blauer Farbgebung, Ep. VIZXBENET, fourgon porte-autos DDm⁹¹⁶ avec des grilles de protection, livrée bleue, ép. VIZXBENET, vagón plataforma portacoaches DDm⁹¹⁶ para coches, con rejillas de protección, decoración azul, ép. VIZXBENET, car transporter DDm⁹¹⁶ with protective lateral grills, blue livery, ep. VI*Fotomontage / Fotomontaje / Photomontage / Fotomontaggio*

**HR6645****IV**242
C-3**K****FS****NEW****FS, set di 2 carri Gs, cassa a doghe in legno, uno con luci di coda, ep. IV**

FS, 2-tg. Set gedeckter Güterwagen der Bauart Gs (holzbeplante Wände), einer mit roten Schlusslichtern, Ep. IV

FS, coffret de 2 wagons Gs, parois frises de bois, un avec feux fin de convoi, ép. IV

FS, set de dos vagones cerrados tipo Gs, de paredes de tablones, uno con luz de cola, ép. IV

FS, 2-unit pack Gs wagons (walls made from wooden planks), one with red rear lights, ep. IV

Assi sostitutivi per corrente alternata: HC6101 (11.27 x 24.25 mm)



Con luci di coda
Mit roten Schlusslichtern
Avec feux fin de convoi
Con luz de cola
With red rear lights

Luci di coda

- Esatta riproduzione delle lanterne di coda di tipo FS.
- Le luci rosse sono funzionanti, con un realistico lampeggio asincrono tra le due lanterne.
- L'alimentazione è garantita da una pila a bottone all'interno del carro (non fornita).
- Il funzionamento delle luci di coda è controllato da un magnete (incluso nella confezione). Sulla testata del carro equipaggiato con luci di coda vi è un contatto reed nascosto subito sotto il tetto del carro. Avvicinando il magnete vicino alla fine del tetto di questo carro, il contatto reed viene attivato e le luci di coda vengono accese o spente.

**HR6599****IV**534
C-3**K****DB****DB, set di 2 carri a pareti scorrevoli, livrea argento, "Cargowaggon", ep. IV**

DB, 2-tg. Set Schiebewandwagen in silberner Farbgebung, „Cargowaggon“, Ep. IV

DB, coffret de 2 wagons à parois coulissantes, livrée argent, « Cargowaggon », ép. IV

DB, set de 2 vagones de paredes correzidas, decoración plata, «Cargowaggon», ép. IV

DR, 2-unit set of sliding walls wagons, silver livery, "Cargowaggon", ep. IV

Assi sostitutivi per corrente alternata: HC6102 (10.50 x 24.50 mm)



**HR6597****V**534
←→**K****FS****FS, set di 2 carri a pareti scorrevoli Habillss, livrea argento/marrone, ep. V**

FS, 2-tlg. Set Schiebewandwagen Habillss in silber/brauner Farbgebung, Ep. V

FS, coffret de 2 wagons à parois coulissantes Habillss, livrée argent/marron, ép. V

FS, set de 2 wagones de paredes correzidas Habillss, decoración plata/marrón, ép. V

FS, 2-unit set of sliding walls wagon Habillss, silver/brown livery, ep. V

Assi sostitutivi per corrente alternata: HC6102 (10.50 x 24.50 mm)

*Fotomontage / Fotomontaje / Photomontage / Fotomontaggio***HR6598****V-VI**534
←→**K****FS****FS, set di 2 carri a pareti scorrevoli Habillss, livrea XMPR, ep. V-VI**

FS, 2-tlg. Set Schiebewandwagen Habillss in XMPR-Farbgebung, Ep. V-VI

FS, coffret de 2 wagons à parois coulissantes Habillss, livrée XMPR, ép. V-VI

FS, set de 2 wagones de paredes correzidas Habillss, decoración XMPR, ép. V-VI

FS, 2-unit set of sliding walls wagon Habillss, XMPR livery, ep. V-VI

Assi sostitutivi per corrente alternata: HC6102 (10.50 x 24.50 mm)

*Fotomontage / Fotomontaje / Photomontage / Fotomontaggio*

**HR6552****VI****229**
← →**K****FS****NEW****FS, carro pianale a stanti a 4 assi Res, livrea verde, ep. VI**

FS, vierachsiger Rungenwagen der Bauart Res, in grüner Farbgebung, Ep. VI

FS, wagon plateforme à 4 essieux Res, livrée verte, ép. VI

FS, vagón plataforma de teleros tipo Res, decoración verde, ép. VI

FS, 4-axle stake wagon Res, green livery, ep. VI

Assi sostitutivi per corrente alternata: HC6100 (10.27 x 25.20 mm)

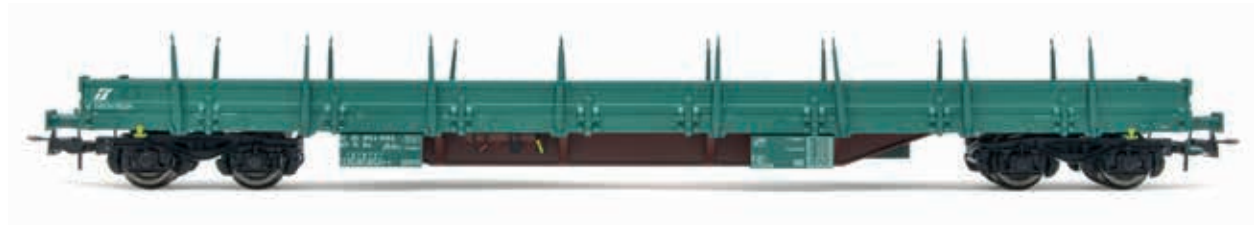
*Fotomontage / Fotomontaje / Photomontage / Fotomontaggio***HR6553****VI****229**
← →**K****FS****NEW****FS, carro pianale a stanti a 4 assi Res, livrea verde, caricato con bobine di filo, ep. VI**

FS, vierachsiger Rungenwagen der Bauart Res, in grüner Farbgebung, beladen mit Drahtrollen, Ep. VI

FS, wagon plateforme à 4 essieux Res, livrée verte, chargement bobines de fil, ép. VI

FS, vagón plataforma de teleros tipo Res, decoración verde, cargado con bobinas de alambre, ép. VI

FS, 4-axle stake wagon Res, green livery, loaded with wire coils, ep. VI

Assi sostitutivi per corrente alternata: HC6100 (10.27 x 25.20 mm)

*Fotomontage / Fotomontaje / Photomontage / Fotomontaggio*

**HR6612****IV-V****388****K****FS****NEW****FS, set di 2 carri pianale a 4 assi composto da 1 carro Rgs caricato con 2 container da 20 piedi e 1 carro Rgmms caricato con 2 veicoli militari M113, ep. IV-V**

FS, 2-tlg. Set Flachwagen, bestehend aus 1 x Rgs beladen mit 2 x 20' Container und 1 x Rgmms beladen mit zwei Militärfahrzeugen vom Typ M113, Ep. IV-V

FS, coffret de 2 wagons plateforme à 4 essieux, composé d' 1 wagon Rgs chargé avec 2 conteneurs de 20' et 1 wagon Rgmms chargé avec 2 véhicules militaires M113, ép. IV-V

FS, set de 2 wagons plataforma de 4 ejes, compuesto de un vagón Rgs cargado con 2 contenedores de 20' y un Rgmms cargado con 2 vehículos militares, ép. IV-V

FS, 2-unit pack of flat wagons, including 1 x Rgs wagon loaded with 2 x 20' containers and 1 x Rgmms wagon loaded with two military vehicles M113, ep. IV-V

Assi sostitutivi per corrente alternata: HC6100 (10.27 x 25.20 mm)

**HR6647****V-VI****350****K****DB Bahnbau****NEW****DB Bahnbau, set di 2 carri manutenzione, composto da 1 x Res carico di traversine e 1 x Gs, livrea gialla, ep. V-VI**

DB Bahnbau, 2-tlg. Set Bauwagen, beinhaltet 1 x Res beladen mit Schwellen sowie 1 x Gs, beide in gelber Farbgebung, Ep. V-VI

DB Bahnbau, coffret de 2 wagons de maintenance, composé de 1 x Res chargé de traverses et 1 x Gs, livrée jaune, ép. V-VI

DB Bahnbau, set de dos wagons de mantenimiento, compuesto por un vagón Res cargado con traviesas y un Gs, decoración amarillo, yellow livery, ép. V-VI

DB Bahnbau, 2-unit pack maintenance wagons, contains 1 x Res loaded with sleepers and 1 x Gs, both in yellow livery, ep. V-VI

Assi sostitutivi per corrente alternata: (9.60 x 26.00 mm)



**HR6555****FS****NEW****FS, carro pianale a 4 assi Rgs, caricato con 2 coil container “Gruppo Bernardini” da 20 piedi, ep. V**

FS, 4-achs. Flachwagen Rgs, beladen mit 2 x 20' Coil-Container „Gruppo Bernardini“, Ep. V

FS, wagon plateforme à 4 essieux Rgs, chargé avec 2 conteneurs porte-bobines de 20' « Gruppo Bernardini », ép. V

FS, vagón plataforma de teleros tipo Rgs, cargado con 2 Coil-container de 20' “Gruppo Bernardini”, ép. V

FS, flat wagon Rgs, loaded with 2 x 20' coil containers “Gruppo Bernardini”, ep. V

Assi sostitutivi per corrente alternata: HC6100 (10.27 x 25.20 mm)

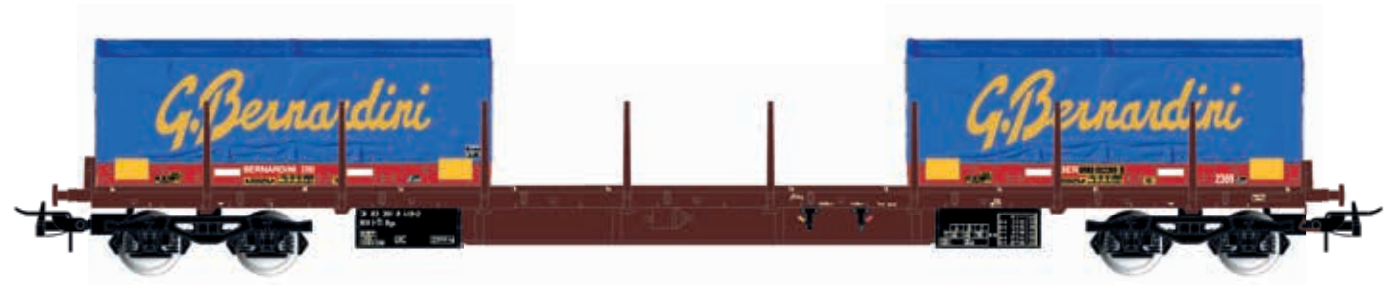
**HR6558****DB Schenker****NEW****DB, carro porta container a 4 assi Rglns, livrea rossa, caricato con 2 Coil-container da 20' “Rheinkraft”, ep. VI**

DB, 4-achs. Containerwagen Rglns, in roter Farbgebung, beladen mit 2 x 20' Coil-Container „Rheinkraft“, Ep. VI

DB, wagon porte-conteneurs à 4 essieux Rglns, livrée rouge, chargé avec 2 conteneurs porte-bobines de 20' « Rheinkraft », ép. VI

DB, vagón portacontenedores tipo Rglns, cargado con 2 Coil-container de 20' “Rheinkraft”, decoración rojo, ép. VI

DB, 4-axle container wagon Rglns, red livery, loaded with 2 x 20' coil containers “Rheinkraft”, ep. VI

Assi sostitutivi per corrente alternata: HC6100 (10.27 x 25.20 mm)



HR6589

VI  465  K

PKP Cargo

NEW

PKP Cargo, set di 3 carri tramoggia a scarico automatico a 4 assi Fals, livrea blu/gialla, ep. VI

PKP Cargo, 3-tlg. Set 4-achs.Selbstentladwagen Fals, in blau/gelber Farbgebung, Ep. VI

PKP Cargo, coffret de 3 wagons à déchargement automatique à 4 essieux Fals, livrée bleue/jaune, ép. VI

PKP Cargo, set de 3 wagones con autodescarga de 4 ejes Fals, decoración azul/amarillo, ép. VI

PKP Cargo, 3-unit pack of 4-axle self-discharging wagons Fals, blue/yellow livery, ep. VI



HR6590

VI  465  K

AWT

NEW

AWT, set di 3 carri tramoggia a scarico automatico a 4 assi Fals, livrea grigia, ep. VI

AWT, 3-tlg. Set 4-achs.Selbstentladwagen Fals, in grauer Farbgebung, Ep. VI

AWT, coffret de 3 wagons à déchargement automatique à 4 essieux Fals, livrée gris, ép. VI

AWT, set de 3 wagones con autodescarga de 4 ejes Fals, decoración gris, ép. VI

AWT, 3-unit pack of 4-axle self-discharging wagons Fals, grey livery, ep. VI





HR6625

VI

177

K

DB

NEW

DB, carro tramoggia a 4 assi per il trasporto di cereali con pareti tonde, "Aurora", ep. V

DB, 4-achs. Schwenkdachwagen mit gewölbten Silowänden für den Getreidetransport, „Aurora“, Ep. V

DB, wagon-trémie à 4 essieux avec parois rondes pour le transport de céréales, « Aurora », ép. V

DB, vagón tolva de 4 ejes con paredes redondas para cereales, «Aurora», ép. V

DB, 4-axle hopper wagon with rounded walls for cereal transport, "Aurora", ep. V



HR6624

VI

342

K

CZ-Interfracht

NEW

CZ-Interfracht, set di 2 carri tramoggia a 4 assi con pareti tonde, ep. VI

CZ-Interfracht, 2-tlg. Set 4-achs. Schwenkdachwagen mit gewölbten Silowänden, Ep. VI

CZ-Interfracht, coffret de 2 wagons trémies à 4 essieux avec parois rondes, ép. VI

CZ-Interfracht, set de 2 wagones tolva de 4 ejes con paredes redondas, ép. VI

CZ-Interfracht, 2-unit set of 4-axle hopper wagons with rounded walls, ep. VI



**HR6546****VI****362****K****NACCO****NEW****NACCO, set di 2 carri tramoggia a 4 assi Taos, livrea gialla, "Josera", ep. VI**

NACCO, 2-tlg. Set 4-achs. Schwenkdachwagen Taos, in gelber Farbgebung, „Josera“, Ep. VI

NACCO, coffret de 2 wagons trémie à 4 essieux Taos, livrée jaune, « Josera », ép. VI

NACCO, set de dos vagones tolva tipo Taos, decoración amarilla "Josera", ép. VI

NACCO, 2-unit pack of 4-axle hopper wagons Taos, yellow livery, "Josera", ep. VI

Assi sostitutivi per corrente alternata: HC6100 (10.27 x 25.20 mm)

Die neuen Schwenkdachwagen der Bauart Taos

Die Schwenkdachwagen des Typs Taos wurden ab den 1970er Jahren beschafft. Bis heute werden sie hauptsächlich für den Transport von Quarzsand, Kalk und Tierfutter verwendet und kommen häufig in Ganzzügen zum Einsatz. Aufgrund der über die vergangenen Jahrzehnte wechselnden Besitzer und Mieter dieser Waggonen werden uns die neuen Rivarossi-Modelle in den nächsten Jahren interessante Varianten an Formen und Beschriftungen bieten.

**HR6547****VI****362****K****D-VTGCH****NEW****D-VTGCH, set di 2 carri tramoggia a 4 assi Taos, livrea grigia, ep. VI**

D-VTGCH, 2-tlg. Set 4-achs. Schwenkdachwagen Taos, in grauer Farbgebung, Ep. VI

D-VTGCH, coffret de 2 wagons trémie à 4 essieux Taos, livrée gris, ép. VI

D-VTGCH, set de dos vagones tolva tipo Taos, decoración gris, ép. VI

D-VTGCH, 2-unit pack of 4-axle hopper wagons Taos, grey livery, ep. VI

Assi sostitutivi per corrente alternata: HC6100 (10.27 x 25.20 mm)





HR6620

IV

242

K

FS

NEW

FS, set di 2 carri cisterna a 2 assi Zgkk, "Agipgas", ep. IV

FS, 2-tlg. Set 2-achs. Gaskesselwagen, „Agipgas“, Ep. IV

FS, coffret de 2 wagons-citernes à gaz à 2 essieux Zgkk, « Agipgas », ép. IV

FS, set de 2 wagones cisterna de gas de 2 ejes Zgkk, «Agipgas», ép. IV

FS, 2-unit set of 2-axle gas tank wagons, "Agipgas", ep. IV



Assi sostitutivi per corrente alternata: HC6101 (11.27 x 24.25 mm)



HR6621

IV

242

K

FS

NEW

FS, set di 2 carri cisterna a 2 assi per trasporto gas, livrea argento, "Pibigas", ep. IV

FS, 2-tlg. Set 2-achs. Gaskesselwagen in silberner Farbgebung, „Pibigas“, Ep. IV

FS, coffret de 2 wagons citernes à 2 essieux à gaz, livrée argent, « Pibigas », ép. IV

FS, set de 2 wagones cisternas, decoración plata, «Pibigas», ép. IV

FS, 2-unit set of 2-axle gas tank wagons, silver livery, "Pibigas", ep. IV



Assi sostitutivi per corrente alternata: HC6101 (11.27 x 24.25 mm)

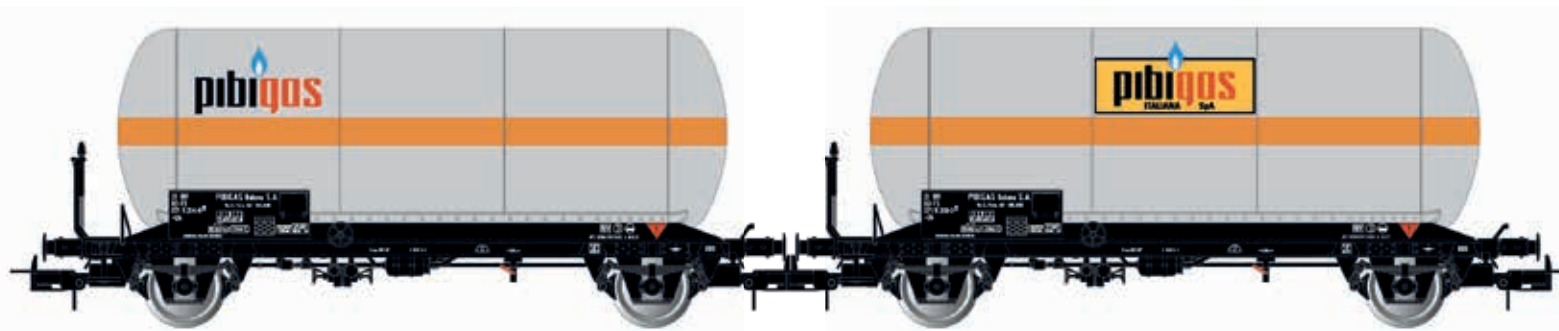



HR6618 **IV-V** ²⁴²_{← →} **K** **DB**

NEW

DB, set di 2 carri cisterna a 2 assi Zgs per trasporto gas, "BASF", ep. IV-V

DB, 2-tlg. Set 2-achs. Gaskesselwagen Zgs, „BASF“, Ep. IV-V
DB, coffret de 2 wagons citernes à 2 essieux Zgs à gaz, « BASF », ép. IV-V
DB, set de 2 wagons cisternas de 2 ejes Zgs, «BASF», ép. IV-V
DB, 2-unit set of 2-axle gas tank wagons Zgs, "BASF", ep. IV-V

Assi sostitutivi per corrente alternata: HC6101 (11.27 x 24.25 mm)



HR6619 **V** ²⁴²_{← →} **K** **DB**

NEW

DB, set di 2 carri cisterna a 2 assi Zgkk con tetto apribile, "VTG", ep. V

DB, 2-tlg. Set 2-achs. Gaskesselwagen mit Sonnenschutzdach, „VTG“, Ep. V
DB, coffret de 2 wagons-citernes à gaz à 2 essieux Zgkk avec toit ouvrant, « VTG », ép. V
DB, set de 2 wagons cisterna de gas de 2 ejes Zgkk con techo solar, «VTG», ép. V
DB, 2-unit set of 2-axle gas tank wagons with sun roof, "VTG", ep. V

Assi sostitutivi per corrente alternata: HC6101 (11.27 x 24.25 mm)



HR6622 **V** ²⁴²_{← →} **K** **SBB**

NEW

SBB, set di 2 carri cisterna a 2 assi per trasporto gas, "Wascosa", ep. V

SBB, 2-tlg. Set 2-achs. Gaskesselwagen, „Wascosa“, Ep. V
SBB, coffret de 2 wagons citernes à 2 essieux à gaz, « Wascosa », ép. V
SBB, set de 2 wagons cisterna de 2 ejes, «Wascosa», ép. V
SBB, 2-unit set of 2-axle gas tank wagons, "Wascosa", ep. V

Assi sostitutivi per corrente alternata: HC6101 (11.27 x 24.25 mm)



HR6646VI  K

TRANSFESA

NEW**TRANSFESA/Hispanauto, carro trasporto auto a 3 assi tipo Laeks "Mega Car Carrier", livrea argento, ep. VI**

TRANSFESA/Hispanauto, dreiachsiger Autotransportwagen der Bauart Laeks „Mega Car Carrier“, silberne Farbgebung, Ep. VI

TRANSFESA/Hispanauto, wagon porte-autos à 3 essieux Laeks « Mega Car Carrier », livrée argent, ép. VI

TRANSFESA/Hispanauto, vagón portacoche tipo Laeks "Mega Car Carrier", decoración azul/plata, ép. VI

TRANSFESA/Hispanauto, 3-axle car transporter Laeks "Mega Car Carrier", silver livery, ep. VI

Assi sostitutivi per corrente alternata: HC6103

HR6600IV-V  K

FS

FS, carro articolato a 3 assi telonato tipo Lails, "Ausiliare Milano", ep. IV-V

FS, dreiachsiger Schiebepflanwagen Lails, „Ausiliare Milano“, Ep. IV-V

FS, wagon bâché à 3 essieux type Lails, « Ausiliare Milano », ép. IV-V

FS, vagón articulado entoldado tipo Lails de 3 ejes, "Ausiliare Milano", ép. IV-V

FS, 3-axle tarpaulin wagon Lails, "Ausiliare Milano", ep. IV-V

Assi sostitutivi per corrente alternata: HC6103





HR6601 **V** **304** **K** **FS**

FS, carro articolato a 3 assi telonato tipo Lails, "Indesit", ep. V

FS, dreiaxssiger Schiebepplanenwagen Lails, „Indesit“, Ep. V
FS, wagon bâché à 3 essieux type Lails, « Indesit », ép. V
FS, vagón articulado entoldado tipo Lails de 3 ejes, "Indesit", ép. V
FS, 3-axle tarpaulin wagon Lails, "Indesit », ep. V

Assi sostitutivi per corrente alternata: HC6103



HR6602 **V** **304** **K** **FS**

FS, carro articolato a 3 assi telonato tipo Lails, "Indesit + Ariston + Scholtès", ep. V

FS, dreiaxssiger Schiebepplanenwagen Lails, „Indesit + Ariston + Scholtès“, Ep. V
FS, wagon bâché à 3 essieux type Lails, « Indesit + Ariston + Scholtès », ép. V
FS, vagón articulado entoldado tipo Lails de 3 ejes, "Indesit + Ariston + Scholtès", ép. V
FS, 3-axle tarpaulin wagon Lails, "Indesit + Ariston + Scholtès », ep. V

Assi sostitutivi per corrente alternata: HC6103



HR6603 **V** **304** **K**

Carro articolato a 3 assi telonato tipo Lails, "Delacher + Co", ep. V

Dreiaxssiger Schiebepplanenwagen Lails, „Delacher + Co“, Ep. V
Wagon bâché à 3 essieux type Lails, « Delacher + Co », ép. V
Vagón articulado entoldado tipo Lails de 3 ejes, "Delacher + Co", ép. V
3-axle tarpaulin wagon Lails, "Delacher + Co », ep. V

Assi sostitutivi per corrente alternata: HC6103





© Gary Everhart



HR2950/HR2950S



Chesapeake & Ohio

NEW

Chesapeake & Ohio, locomotiva a vapore articolata 2-6-6-6 "Allegheny", n. 1601

Chesapeake & Ohio, schwere Güterzugdampflokomotive der Bauart 2-6-6-6 „Allegheny“, Betriebsnummer 1601

Chesapeake & Ohio, locomotive à vapeur articulée 2-6-6-6 « Allegheny », #1601

Chesapeake & Ohio, locomotora de vapor articulada 2-6-6-6 "Allegheny" 1601

Chesapeake & Ohio, articulated steam locomotive 2-6-6-6 "Allegheny", #1601



- Con forno illuminato (DC) o scoppiettante (in digitale)
- Mit glühender (DC) bzw. flackerner (im Digitalbetrieb) Feuerbüchse
- Avec boîte à feu lumineuse (DC) ou scintillant (en mode digital)
- Con fogón iluminado (DC) o parpadeando (en modo digital)
- With glowing (DC) or flickering (in digital mode) firebox



HR2951/HR2951S



Chesapeake & Ohio

NEW

Chesapeake & Ohio, locomotiva a vapore articolata 2-6-6-6 "Allegheny", n. 1632

Chesapeake & Ohio, schwere Güterzugdampflokomotive der Bauart 2-6-6-6 „Allegheny“, Betriebsnummer 1632

Chesapeake & Ohio, locomotive à vapeur articulée 2-6-6-6 « Allegheny », #1632

Chesapeake & Ohio, locomotora de vapor articulada 2-6-6-6 "Allegheny" 1632

Chesapeake & Ohio, articulated steam locomotive 2-6-6-6 "Allegheny", #1632



- Con forno illuminato (DC) o scoppiettante (in digitale)
- Mit glühender (DC) bzw. flackerner (im Digitalbetrieb) Feuerbüchse
- Avec boîte à feu lumineuse (DC) ou scintillant (en mode digital)
- Con fogón iluminado (DC) o parpadeando (en modo digital)
- With glowing (DC) or flickering (in digital mode) firebox



HR2952/HR2952S



Chesapeake & Ohio

NEW

Chesapeake & Ohio, locomotiva a vapore articolata 2-6-6-6 "Allegheny", n. 1653

Chesapeake & Ohio, schwere Güterzugdampflokomotive der Bauart 2-6-6-6 „Allegheny“, Betriebsnummer 1653

Chesapeake & Ohio, locomotive à vapeur articulée 2-6-6-6 « Allegheny », #1653

Chesapeake & Ohio, locomotora de vapor articulada 2-6-6-6 "Allegheny" 1653

Chesapeake & Ohio, articulated steam locomotive 2-6-6-6 "Allegheny", #1653



- Con forno illuminato (DC) o scoppiettante (in digitale)
- Mit glühender (DC) bzw. flackerner (im Digitalbetrieb) Feuerbüchse
- Avec boîte à feu lumineuse (DC) ou scintillant (en mode digital)
- Con fogón iluminado (DC) o parpadeando (en modo digital)
- With glowing (DC) or flickering (in digital mode) firebox

**HR3023****Union Pacific****NEW****Union Pacific, tender per olio combustibile "Centipede", ad esempio per locomotive della serie 4000 "Big Boy"**

Union Pacific, „Centipede“ Öltender, u.a. für Lokomotiven der Reihe 4000 „Big Boy“

Union Pacific, tender à carburant « Centipede », par exemple pour les locomotives de la série 4000 « Big Boy »

Union Pacific, tender de fuel "Ciempiés", por ejemplo para locomotoras de la serie 4000 "Big Boy"

Union Pacific, "Centipede" fuel tender, among others for class 4000 locomotives "Big Boy"

**HR6661A****ATSF****NEW****ATSF, carro a porte scorrevoli "San Francisco Chief" senza passerella sul tetto, n. 12711**

ATSF, gedeckter Güterwagen mit Schiebetüren „San Francisco Chief“ ohne Dachsteg, Betriebsnr. 12711

ATSF, wagon couvert à portes coulissantes « San Francisco Chief » sans passerelle de toit, n° 12711

ATSF, US Boxcar 12711, con pasarela de techo, decoración "San Francisco Chief"

ATSF, sliding door boxcar "San Francisco Chief" without roof walkway, #12711

Other running numbers available under the following references:

HR6661B: ATSF, sliding door boxcar "San Francisco Chief" without roof walkway, #12712

HR6661C: ATSF, sliding door boxcar "San Francisco Chief" without roof walkway, #12746

HR6661D: ATSF, sliding door boxcar "San Francisco Chief" without roof walkway, #12755

Assi sostitutivi per corrente alternata: (9.60 x 26.00 mm)

**HR6662A****ATSF****NEW****ATSF, carro a porte scorrevoli "Texas Chief" senza passerella sul tetto, n. 12801**

ATSF, gedeckter Güterwagen mit Schiebetüren „Texas Chief“ ohne Dachsteg, Betriebsnr. 12801

ATSF, wagon couvert à portes coulissantes « Texas Chief » sans passerelle de toit, n° 12801

ATSF, US Boxcar 12801, sin pasarela de techo, decoración "Texas Chief"

ATSF, sliding door boxcar "Texas Chief" without roof walkway, #12801

Other running numbers available under the following references:

HR6662B: ATSF, sliding door boxcar "Texas Chief" without roof walkway, #12821

HR6662C: ATSF, sliding door boxcar "Texas Chief" without roof walkway, #12844

HR6662D: ATSF, sliding door boxcar "Texas Chief" without roof walkway, #12850

Assi sostitutivi per corrente alternata: (9.60 x 26.00 mm)



**HR6663A****P&LE****NEW****P&LE, carro con portelloni ad espulsione/scorrevoli, livrea blu chiaro senza passerella sul tetto, n. 6458**

P&LE, gedeckter Güterwagen mit Schwenkschiebetüren, hellblaue Farbgebung ohne Dachsteg, Betriebsnr. 6458

P&LE, wagon couvert, portes coulissantes-pivotantes, livrée bleu clair sans passerelle de toit, n° 6458

P&LE, US Boxcar 6458, decoración azul claro

P&LE, plug door boxcar, light blue livery without roof walkway, #6458

Other running numbers available under the following references:

HR6663B: P&LE, plug door boxcar, light blue livery without roof walkway, #6450

HR6663C: P&LE, plug door boxcar, light blue livery without roof walkway, #6499

HR6663D: P&LE, plug door boxcar, light blue livery without roof walkway, #6467

**HR6664A****Erie Lackawanna****NEW****Erie Lackawanna, carro con portelloni ad espulsione/scorrevoli, con passerella sul tetto, n. 68398**

Erie Lackawanna, gedeckter Güterwagen mit Schwenkschiebetüren und Dachsteg, Betriebsnr. 68398

Erie Lackawanna, wagon couvert, portes coulissantes-pivotantes, avec passerelle de toit, n° 68398

Erie Lackawanna, US Boxcar 68398, con pasarela de techo

Erie Lackawanna, plug door boxcar, with roof walkway, #68398

Other running numbers available under the following references:

HR6664B: Erie Lackawanna, plug door boxcar, with roof walkway, #68439

HR6664C: Erie Lackawanna, plug door boxcar, with roof walkway, #68360

HR6664D: Erie Lackawanna, plug door boxcar, with roof walkway, #68386

Assi sostitutivi per corrente alternata: (9.60 x 26.00 mm)

**HR6665A****Northern Pacific****NEW****Northern Pacific, carro con portelloni ad espulsione/scorrevoli, livrea verde senza passerella sul tetto, n. 98111**

Northern Pacific, gedeckter Güterwagen mit Schwenkschiebetüren, grüne Farbgebung ohne Dachsteg, Betriebsnr. 98111

Northern Pacific, wagon couvert, portes coulissantes-pivotantes, livrée verte sans passerelle de toit, n° 98111

Northern Pacific, US Boxcar 98111, decoración verde

Northern Pacific, plug door boxcar, green livery without roof walkway, #98111

Other running numbers available under the following references:

HR6665B: Northern Pacific, plug door boxcar, green livery without roof walkway, #98030

HR6665C: Northern Pacific, plug door boxcar, green livery without roof walkway, #98149

HR6665D: Northern Pacific, plug door boxcar, green livery without roof walkway, #98058

Assi sostitutivi per corrente alternata: (9.60 x 26.00 mm)



Già disponibile • Schon verfügbar • Déjà disponible • Ya disponible • Already Available

Certains produits annoncés comme encore « en stock » pourraient être déjà épuisés

Einige der hier als bereits verfügbar gekennzeichneten Produkte können bereits ab Lager ausverkauft sein.

I prodotti qui mostrati come disponibili potrebbero essere già esauriti.

Algunos de los productos marcados como ya disponibles podrían estar agotados ya.

Some items shown here as still available could already be sold out ex-works.

HR2787/HR2787S

FS, steam locomotive Gr. 835, oil lamps, riveted lateral water tanks, period III-IV



HR2788/HR2888S

FS, steam locomotive Gr. 835, oil lamps, soldered lateral water tanks, period III-IV



HR2789/HR2789S

FS, steam locomotive Gr. 835, electric lamps, big Westinghouse pump, period III-IV



HR2790/HR2790S

FS, steam locomotive Gr. 835, electric lamps, big Westinghouse pump, period III-IV



HR2807/HR2807S

KPEV, steam locomotive G 8.1, green/black livery, period I



HR2808/HR2808S

DRG, steam locomotive class 55.25 (ex Pr. G 8.1), black/red livery, period II



HR2809/HR2809S

DB, steam locomotive class 55.25 (ex Pr. G 8.1), black/red livery, period III



HR2811

FS, steam locomotive Gr. 460, 3-dome boiler, oxide red/black livery, white markings, period II



HR2917/HR2917S

FS, steam locomotive Gr. 835 with oil lamps, period III





HR2918/HR2918S

FS, steam locomotive Gr. 835 with electric lamps and white wheel rims, period III-IV



HR2882/HR2882S

Heisler Steam locomotive, 2-Truck model, "The Curtiss Lumber Co. #2", period III



HR2883/HR2883S

Heisler Steam locomotive, 2-Truck model, "Northern Redwood Lumber Company #4", period III



HR2793/HR2793S

FS, diesel locomotive class D.245, green livery with modern handrails, period V



HR2794/HR2794S

FS, diesel locomotive D.250 2001, orange livery, period V



HR2795/HR2795S

FS, diesel locomotive D.250 2001, orange livery, period V



HR2796/HR2796/S

FS, diesel locomotive D.250 2001, orange livery, period V-VI



HR2877

AGIP, shunting tractor ABL "Sogliola", yellow livery, with 2 2-axle tank wagons "Agip" livery, period III



HR2897/HR2897S

Mercitalia Shunting & Terminal, diesel shunting locomotive EffiShunter 1000, red/grey livery with white stripes, period VI



HR2898/HR2898S

Rail Traction Company, diesel shunting locomotive EffiShunter 1000, white/black livery, period VI



HR2900/HR2900S

Mercitalia Rail, diesel shunting locomotive EffiShunter 1000, silver livery with red stripes, period VI



HR2928/HR2928S

AWT, diesel locomotive class D.753.7, orange/grey livery, period V-VI



**HR2929/HR2929S**

HUPAC, diesel locomotive class D.753.7, red/light grey livery, period V-VI

**HR2930/HR2930S**

Mercitalia S&T, diesel locomotive class D.753, red/grey livery with white stripes, period VI

**HR2816S**

ÖBB, diesel locomotive 2050.08, vermilion livery, period IV-V, with DCC-Sounddecoder

**HR2818/HR2818S**

ÖBB, diesel locomotive 2050 005-4, traffic red livery, period IV-V

**HR2851/HR2851S**

ÖBB, diesel locomotive class 2050.002, with generator, green livery, period IV

**HR2797/HR2797D**

FS, electric locomotive E.652 108, silver/red "FS Mercitalia" livery, period IV

**HR2867/HR2867S**

FS, electric locomotive E.646, 2nd series, green/grey livery with aluminium stripes, period IIIb

**HR2868S**

FS, electric locomotive E.646, 2nd series, "Treno Azzurro" livery, period IIIb, with DCC-sounddecoder

**HR2871/HR2871S**

FS, electric locomotive E.646, 2nd series, "Navetta" MDVC livery and dark grey roof, period IVb

**HR2873/HR2873S**

FS, electric locomotive E.424, castano/isabella livery, period IV

**HR2874/HR2874S**

FS, electric locomotive E.424, isabella livery, period V

**HR2875/HR2875S**

FS, 2-unit set electric locomotives E.633 200 series, blue/grey livery, period IV-V



**HR2876/JR2876S**

FS, electric locomotive E.632 with pantographs 52, blue/grey livery with FS "a losanga" logo, period V

**HR2902/HR2902S**

FS, electric locomotive E.428, semi-aerodynamic design, driving wheels with original transmission, period IVa

**HR2904/HR2904S**

FS, electric locomotive E.402B, new "Frecciabianca" livery, ep. VI

**HR2905/HR2905S**

FS RFI, electric locomotive E.402B, yellow/blue livery, period VI

**HR2699D**

FS, electric locomotive class E.652 004 prototype, with type 52 pantograph, original livery, period IV-V

**HR2701D**

FS, electric locomotive class E.652 088, original livery with big running number on the frontal sides, period IV-V

**HR2854/HR2854S**

ÖBB, electric locomotive 1046 009-5, "Valousek" livery, period IV-V

**HR2855/HR2855S**

ÖBB, electric locomotive 4061.17, vermillion livery, period IV

**HR2856/HR2856S**

ÖBB, electric locomotive 1046 001-2, red/grey livery, period V

**HR2819D/HR2819S**

ÖBB, electric locomotive class 1040, green livery, period III-IV

**HR2820D/HR2820S**

ÖBB, electric locomotive class 1040, vermillion livery with old logo, period IV

**HR2853S**

DB, electric locomotive E 33 020, green livery, period III-IV



**HR4286**

FS, 2-unit set of coaches UIC-Z renovated (progetto 901/300), XMPR livery, including 1 2nd class (ex 1st class) coach and 1 2nd class coach, period VI

**HR4351**

FS, 2-unit set of 1st class coaches Gran Confort '85 "Progetto 901", "Frecciabianca" livery with red doors, period VI

**HR4355**

FS, 2-unit set of 2nd class coaches UIC-Z1 "Progetto 901", "Frecciabianca" livery with red doors, period VI

**HR4363**

FS, luggage van UIC-X '70 with large fairings, grey livery, ep. IV

**HR4318**

FS, 3-unit set "Celerone", including 1 x Ulz 1400 mail van in grey livery, 1 x DUz 93100 luggage/mail van in grey livery and 1 x closed wagon Hcs-uvvy with bellows, period IV

**HR4353**

FS, 2-units set of Gran Confort 1985 open space coaches, "Bandiera" livery, including 1 coach A and 1 coach AH with handicap seats, period V

**HR4357**

FS, 2-units pack UIC-Z1 rebuilt 2nd class, Intercity Notte Basic livery blue with red stripe, ep. VI

**HR4369**

FS, 3-unit set of 2-axle "Corbellini" 1947 3rd class coaches for historic trains, castano/Isabella livery, period V-IV

**HR4324**

FS, 4-unit set of "Treno Azzurro" coaches, including 2 1st class Type 1946 Az13025 coaches and 2 2nd class Type 1946 Bz33010 coaches, one with "ristoro" compartment, period IIIb

**HR4354**

FS, 2-units set of Gran Confort 1985 open space coaches, XMPR livery, including 1 coach A and 1 coach AH with handicap seats, period V-VI

**HR4358**

FS, 3-unit set of IC 572/579 coaches "Petruzzelli", Milan - Bari, "Bandiera" livery, including 1 salon coach Gran Confort 1985, 1 coach with compartments Gran Confort 1985 and 1 restaurant coach Gran Confort WR83 with smooth roof, period V

**HR4370**

FS, 2-unit set of "Corbellini" 1947 coaches, grey livery, including 1 2-axle coach and 1 4-axle coach, period IV



**HR4333**

CIWL, sleeping coach MU '64 WMD, matriculated in the fleet of the DB, period IV

**HR4334**

SBB, sleeping coach MU '64 WMD with big skirts, TEN livery with aluminium roof, period IV

**HR4335**

SBB, sleeping coach MU '68, "Mond und Sterne" livery, period V

**HR4301**

ÖBB, sleeping coach MU, "TEN" livery with blue roof, period IV-V

**HR4302**

DB, sleeping coach MU, "TEN" livery with aluminium roof, period IV

**HR4293**

ALEX, 3-unit pack passenger coaches type UIC-Z, 2nd class in grey/white livery, period VI

**HR4305**

3-unit pack "TEE Helvetia", ARD+mh¹⁰⁵, Apümh¹²¹ and Avümh¹¹¹

**HR4306**

3-unit pack "TEE Helvetia" Hamburg-Zürich, WRmh¹³² DB + 2 Avmz¹¹¹ DB, TEE livery, ep. IV

**HR4327**

DR, 3-unit set of coaches, green livery, including 1 1st class coach, 1 1st/2nd class coach and 1 sleeperette coach, period III

**HR4328**

DR, 3-unit set of coaches, including 2 2nd class coaches in green livery and 1 Mitropa restaurant coach, period III

**HR4344**

DR, 3-unit set of OSShD Type B coaches, beige/green livery, including 1 1st class coach A, 1 1st/2nd class coach AB and 1 2nd class coach Bc, period IV

**HR4345**

DR, 3-unit set of OSShD Type B coaches, including 2 2nd class coach B in beige/green livery and 1 restaurant coach WR in red livery, period IV



**HR4371**

DR, 4-unit of double-decker coaches without cab-control unit, blue/light grey livery, period IV

**HR4372**

DR, 2-unit of double-decker coaches with cab-control unit, blue/light grey livery, period IV

**HR4379**

DR, 4-unit set of OSShD type B coaches "Tourex", red livery, including 2 coaches WLAB, 1 coach WLABD and 1 coach WR, period IV

**HR6480**

DB, 2-axle closed wagon Gmhs, "MAK", period III

**HR6495**

BR, 4-axle tarpaulin wagon, red "Railfreight Metal" livery, period IV

**HR6496**

BR, 4-axle tarpaulin wagon, blue "Easiloader" livery, period IV

**HR6497**

BR, 4-axle tarpaulin wagon, blue "Cargowaggon" livery, period IV

**HR6502**

ERR, 4-axle flat wagon Sg, brown livery, loaded with 2 20' container "CMA CGM", period VI

**HR6503**

DB, 2-axle closed wagon Gmhs 55 with rear light, period III

**HR6504**

DR, 2-axle closed wagon Gs with rear light, period IV

**HR6505**

FS, 2-unit set of closed wagons Gs with flat walls, brown livery, period IV-V

**HR6506**

FS, 2-unit set of closed wagons Gs with flat walls, brown livery, FS "a losanga" logo, period IV-V



 **HR6507**

FS, 2-unit set of closed wagons Ghs with low aerators, brown livery, period IV-V



 **HR6508**

FS, 2-unit set of service wagons, brown and light grey livery, including 1 x VGs wagon with flat walls and 1 x VGhs wagon with low aerators, period V



 **HR6511**

FS, 2-unit set of 4-axle gas tank wagons Zagkks, "ermewa Autogas" + "Autogas", with orange stripe, period V



 **HR6512**

VTG, 2-unit set of 4-axle gas tank wagons Zags for vinyl chloride transport, grey livery with orange stripe, period V



 **HR6513**

FS, 2-unit set of 4-axle tank wagons Zags/Zas, white livery with and without orange stripe, "Sogetank", period V



 **HR6516**

FS, 4-axle tank wagon Zaes, silver/blue livery, "Montedison", period IV



 **HR6517**

FS, 3-unit set of 2-axle tank wagons VZekk, 27 m³ tank, silver livery with black stripe, period IV-V



 **HR6518**

FS, 2-unit set of 2-axle tank wagons Mop, 27 m³ tank, silver silvery, "Shell", period III



 **HR6519**

FS, 2-unit set of 2-axle tank wagons Md, 27 m³ tank, "Montecatini", period III



 **HR6548**

NACCO, 4-axle tank wagon Zans, blue livery, "Amberger Kaolinwerke", period VI



 **HR6549**

ERMEWA, 4-axle tank wagon Zaens, silver/white livery, "Hoyer", period VI



 **HR6520**

DB AG, 3-unit set of 4-axle self-discharging wagons Fals 164, brown livery, period V





HR6521

DR, 3-unit set of 4-axle self-discharging wagons Fal-zz, brown livery, period IV



HR6551

FS, 3-units pack refrigerated wagons Hgb 2-axes (2 without brakeman's cab, 1 with), white, red stripe, UK loading gauge, ep. III



HR6562

FS, 2-units pack refrigerated wagons Ifms 2-axes without brakeman's cab, metallic doors, white, red stripe, UK loading gauge, ep. IV



HR6563

FS, 2-units pack refrigerated wagons Ifms 2-axes without brakeman's cab, metallic doors, white, red stripe, UK loading gauge, ep. IV



HR6569

FS, 3-axle tarpaulin wagon Las, blue livery, "Ausiliare", period IV



HR6570

FS, 3-axle tarpaulin wagon Lails, grey livery, "Inesit", period V



HR6572

FS, 4-axle tank wagon Us, blue livery, "Ausiliare", period IV



HR6573

FS, 2-axle silo wagon, blue livery, "Ausiliare", period IV



HR6574

DB, 2-unit set of silo wagons Ucs, grey livery, "Höchst", period IV



HR6576

FS CEMAT, 4-axle container wagon Sgnss, brown livery, loaded with 45' container "Trenitalia", period V-VI



HR6578

4-axle container wagon Sgnss, green livery, loaded with 45' container "Warsteiner", period V-VI



HR6591

DB, 2-unit set of silo wagons Ucs, grey livery, "Dyckerhoff", period IV





HR6592

DR-Miet, 2-unit set of silo wagons Ucs, grey and blue livery, "VTG", period IV



HR6604

FS, 2-unit set of 2-axle refrigerated wagons lfms with metallic doors, UK loading gauge, silver livery with red stripe, period IV



HR6605

FS, 3-unit set of 2-axle refrigerated wagons Hgb (2 without brakeman's cab, 1 with), UK loading gauge, silver livery with red stripe, period III



HR6606

FS, 2-unit set of 2-axle refrigerated wagons Hgb, metallic body, UK loading gauge, silver livery, "Cinzano", period III



HR6607

FS, 2-unit of 2-axle tank wagons (1 without brakeman's cab, 1 with), "Mobil", period III



HR6608

ÖBB, 2-axle tank wagon (ex FS), dark grey livery, "ÖMV", period III



HR6609

ÖBB, 2-axle tank wagon (ex FS), dark grey livery, "ÖROP", period III



HR6610

FS, 2-axle closed wagon Gs with flat walls, "Coca-Cola", period IV



HR6611

DB, 2-axle closed wagon Gs with flat walls, "Coca-Cola", period IV



HR6613

CEMAT, 4-axle container wagon Sgnss, green livery, new CEMAT logo, with 45' container "nothegger", ep. VI



HR6614

Mercitalia Intermodal, 4-axle 2-unit pack Sgnss container wagons, blue livery, with 45' containers "P&O Ferrymasters" (blue and yellow), ep. VI



HR6615

FS CEMAT, 4-axle container wagon Sgnss, loaded with 2 20' coil containers "Nizzi", period V-VI





HR6616

FS CEMAT, 4-axle container wagon Sgns, green livery, loaded with 2 20' coil containers "Dani Trasporti", period V-VI



HR6617

FS CEMAT, 4-axle container wagon Sgns, green livery, loaded with 45' container "Italia", period V-VI



HR6634B

Great Northern, US-Boxcar, running number 36829, period III



HR6636C

Canadian Pacific, US-Boxcar with roof walkaway "Newsprint Service Only", running number 80920, period III



HC8061

Locomotive shed one place (without door)



HC8059

Small railway station with good shed and high platform



HC8062

Small toilet



HC8060

Water Tank with small depot below

